

OWNER'S MANUAL

Palsonic

76CM/86CM WIDE SCREEN HDTV READY

MODEL: 76WSHDA

: 86WSHDA



Type Tested
Electrical
Safety

AS/NZS 3250 Lic 4166
Standards Australia
APP No: N18748

PALSONIC CORPORATION PTY LTD
1 JOYNTON AVENUE
WATERLOO NSW 2017 AUSTRALIA
TEL: (02) 9313 7111
FAX: (02) 9313 7555
www.palsonic.com.au

PALSONIC CUSTOMER SERVICE
TELEPHONE
AUSTRALIA: 1300 657 888

Congratulations on your purchase of Palsonic's HDTV ready.

We recommend that you thoroughly read this manual before use to fully enjoy the many functions and excellent effects of this equipment.

Retain this manual in an easily accessible location for future reference.

* Screen displays and illustrations in this manual may differ from the actual ones for better visibility.

Contents

Cautions for safety	1
Locations of controls	3
Remote controller	5
Installation	7
Basic operation	11
Operation in RF mode	13
Channel presetting	13
Channel selection	17
Picture adjustment	18
Sound adjustment	22
Timer setting	24
System setup	25
Operation in VIDEO mode	27
Operation in HDTV mode	28
1. YPbPr	28
2. XGA mode	29
Display mode setting	34
Troubleshooting Guide	35
Specifications	36

Cautions for safety

Cautions for safety

- ◆ *When any unusual situation occurs, turn off the power supply at once and remove the plug from the wall outlet. Contact a qualified service department in your local area.*

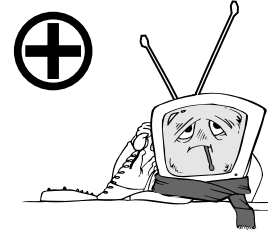

- ◆ *Do not expose the TV set to rain or excessive moisture. Avoid using the set in very warm or damp places and never use it in a bathroom.*



- ◆ *Normally, the screen surface should not be cleaned; however, if it is essential, clean the surface with a soft, dry cloth while the TV is turned off. Never use any detergent cleaners to clean the surface. The screen surface may be scratched if a hard cloth is used.*

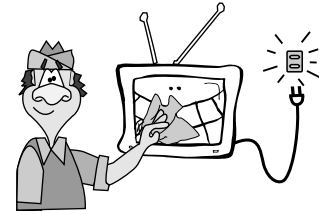

- ◆ *Avoid exposing the set to direct sunlight and other sources of heat to prevent damage to the cabinet and components.*

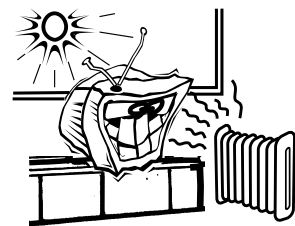

- ◆ *High voltage exists in this TV set. Do not remove the cover.*

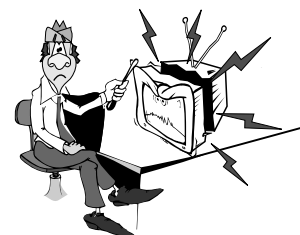

! **Note:** This set can operated on an AC power of 240V, 50Hz. You must not use a power supply of any other type.

◆ *Do not cover the ventilating hole in the cabinet
Keep a space of more than 10cm from the walls to
the TV set to ensure adequate ventilation.*

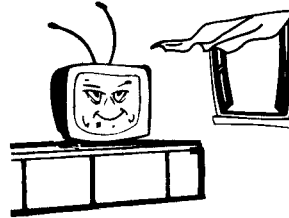

◆ *If the power cord or the plug is damaged contact a
qualified service department for service.*

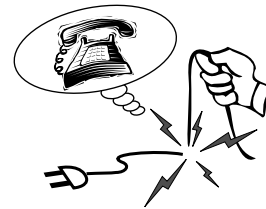

◆ *When the TV set is to be left unattended for a long
period of time, turn off the power supply and remove
the plug from the wall outlet.*

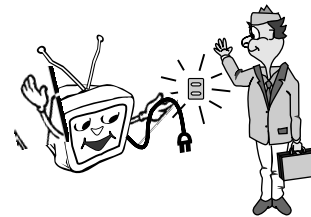

◆ *Don't try to push anything into the cabinet or place
any vessel with water on the TV set.*

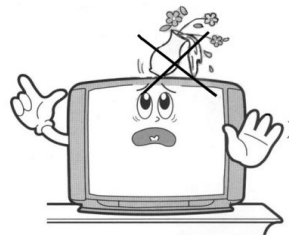

◆ *Don't overload wall outlets; extension cords, or
integral convenience receptacles as this can result
in a risk of fire or electric shock.*

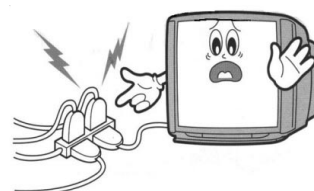

Location of controls

Front view/Side view/Back view

Front view

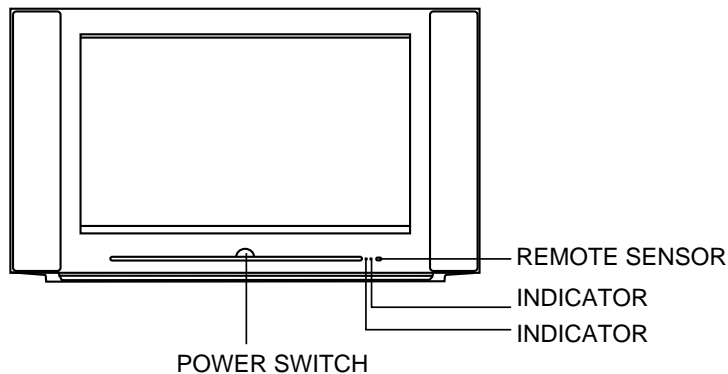

Side view

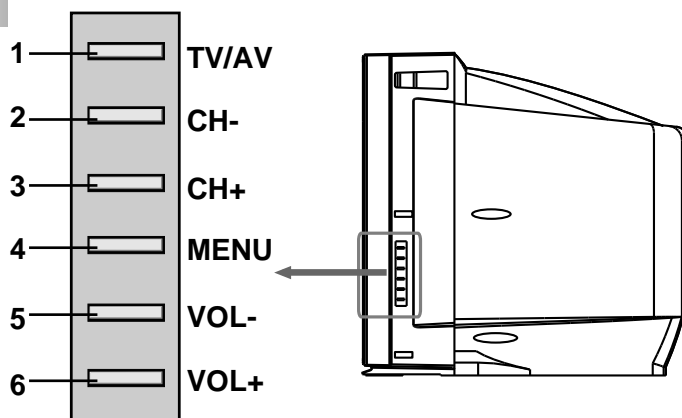

1. **TV/AV** button: Open the signal source selection menu.
2. **CH-** button: Select a lower position number.
3. **CH+** button: Select a higher position number.
4. **MENU** button: Enter into the menu.
5. **VOL-** button: Lower the volume
6. **VOL+** button: Raise the volume.

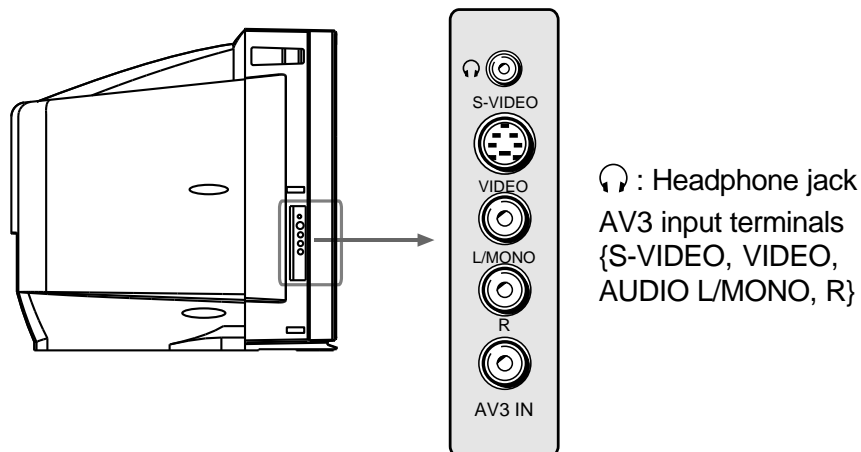

Back view

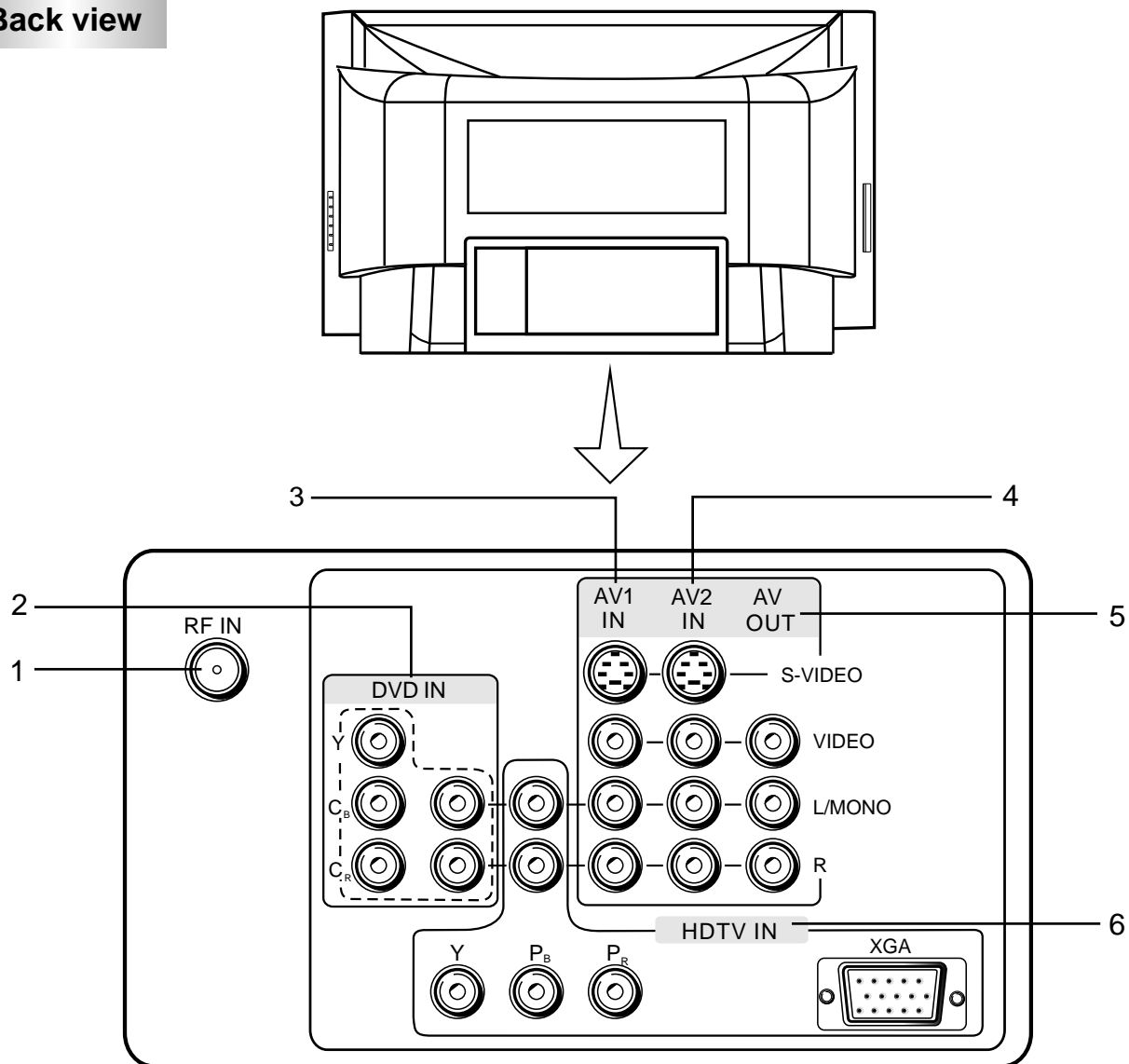

1. Antenna input
2. DVD input terminals { VIDEO: Y, C_B, C_R, AUDIO: L/MONO, R }
3. AV1 input terminals { S-VIDEO, VIDEO, AUDIO: L/MONO, R }
4. AV2 input terminals { S-VIDEO, VIDEO, AUDIO: L/MONO, R }
5. AV output terminals { VIDEO, AUDIO: L/MONO, R }
6. HDTV input { Y, P_B, P_R, XGA, AUDIO: L/MONO, R }

Remote Controller

Remote controller

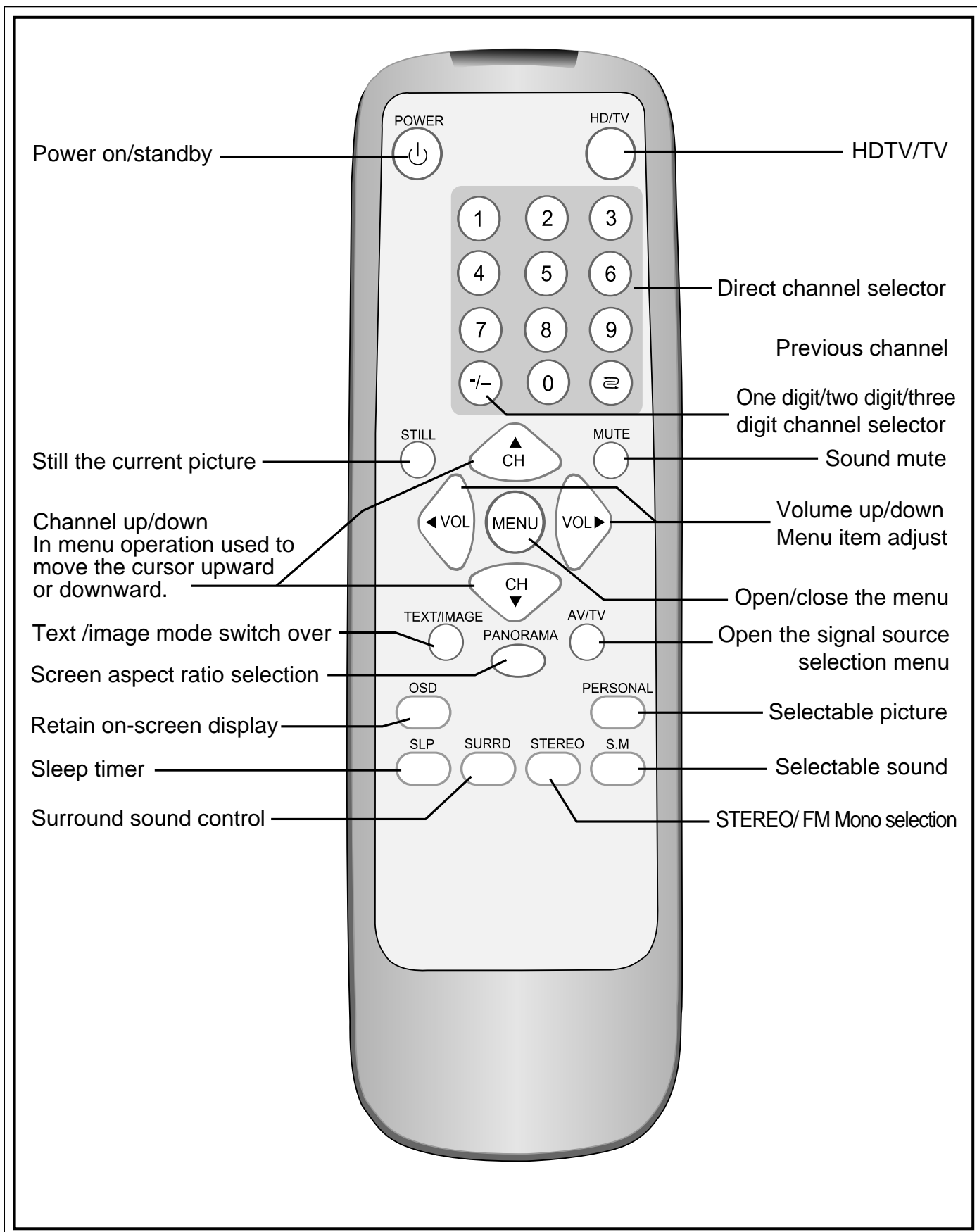

Battery installation

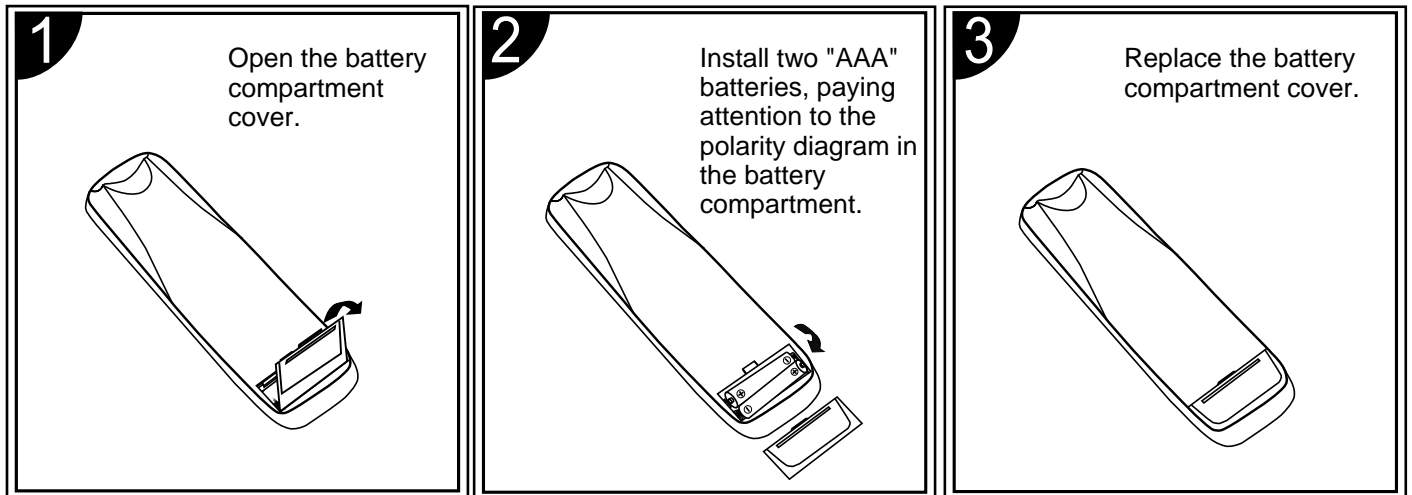

Effective range of the Remote

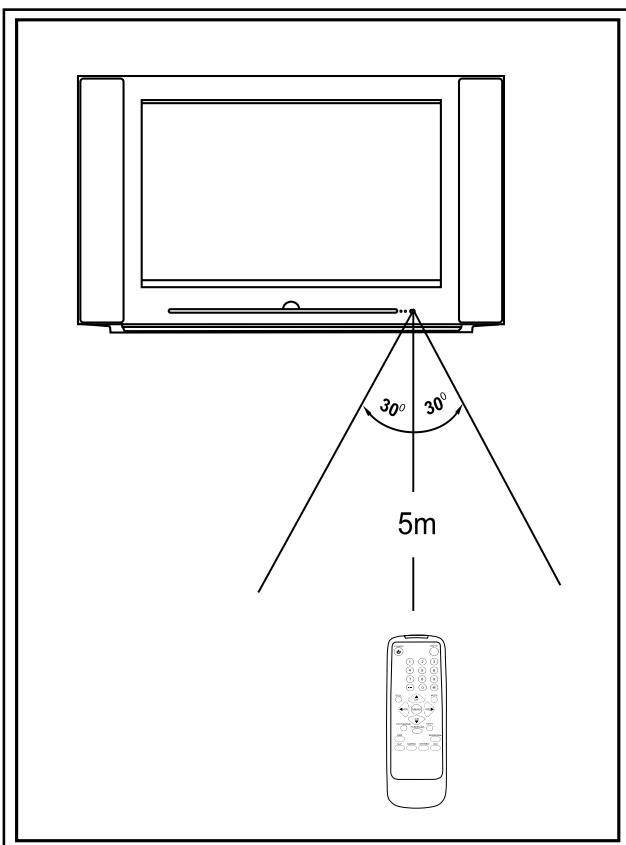

! Notes:

- The battery life should be about one year under normal use. Do not try to recharge batteries not intended to be recharged.
- Use only the size and type of batteries specified. Do not mix different types of batteries together or old batteries with fresh ones.
- When the remote control will not be used for a long period of time or when the batteries are worn out, remove the batteries.
- Do not throw the batteries into a fire. Dispose of used batteries in the specified manner.
- Do not drop, dampen or disassemble the remote control.
- When there is an obstacle between the TV and the transmitter, the transmitter may not operate.
- When direct sunlight, and incandescent lamp, fluorescent lamp or any other strong light shines on the REMOTE SENSOR of the TV, the remote operation may be unstable.

Installation

INSTALL the unit in a room where direct light will not fall upon the screen. Total darkness or a reflection on the picture screen may cause eyestrain. Soft and indirect lighting is recommended for comfortable viewing.

Antenna connection/External equipment connections

Antenna connection

To ensure a bright-coloured and clear picture use an outdoor antenna or CATV cable.

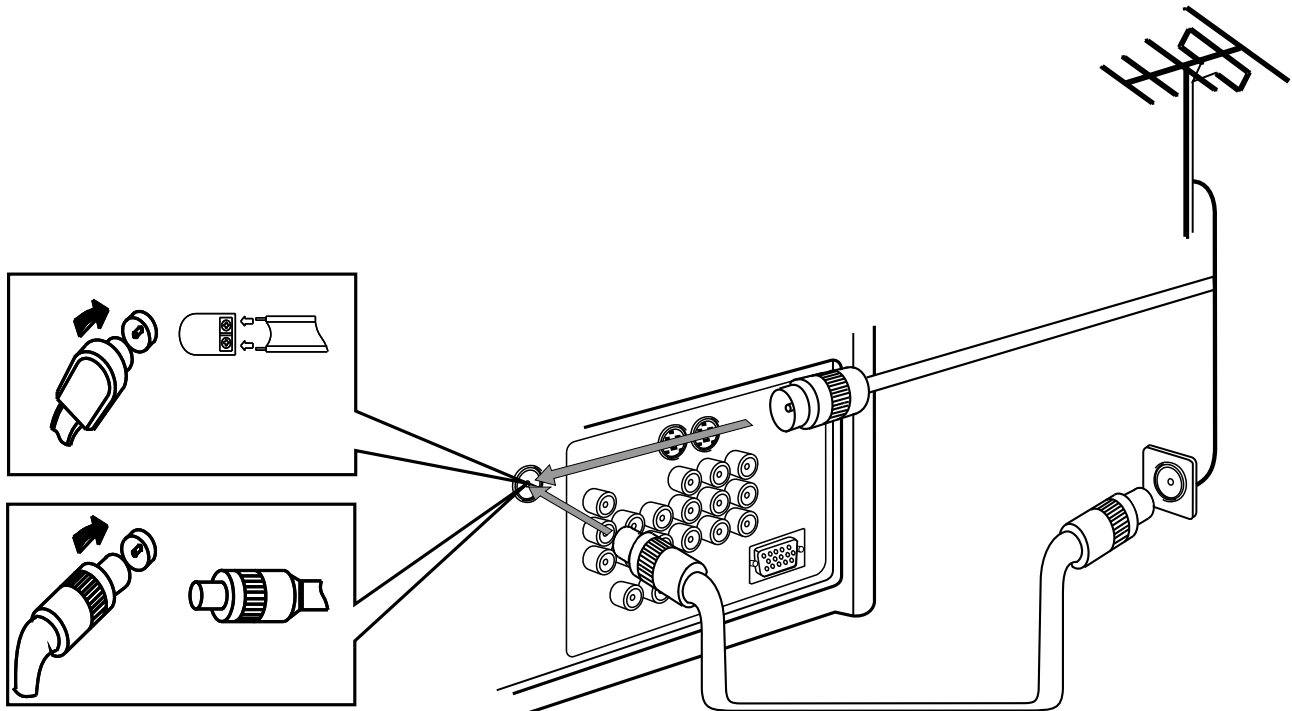

! Note:

In case of using the Twin-lead aerial feeder (300Ω) for UHF/VHF aerial, use a 300-75 ohm adaptor (not supplied)

When using the coaxial cable (75Ω) for UHF/VHF aerial, connect the plug into the 75 ohm aerial socket directly.

! Note:

1. When you connect the outdoor antenna cable to the antenna terminal on the set, turn off the power supply to the set first.
2. In thunder and lightning weather, disconnect the outdoor antenna to avoid lightning strike.
3. When receiving CATV programs, a cable box (not supplied) needs to be used.

External Equipment Connections

(Please the owner's the refer to manual of to equipment be connected as well.)

1. To connect AV input terminals

You can connect video equipments such as a VTR and video camera to this TV and enjoy the high quality picture and sound.

If your video equipment has a S-VIDEO output terminal, connect it to the S-VIDEO input terminal (special S-VIDEO type) of the unit. If not, connect it to the VIDEO terminal (phono type).

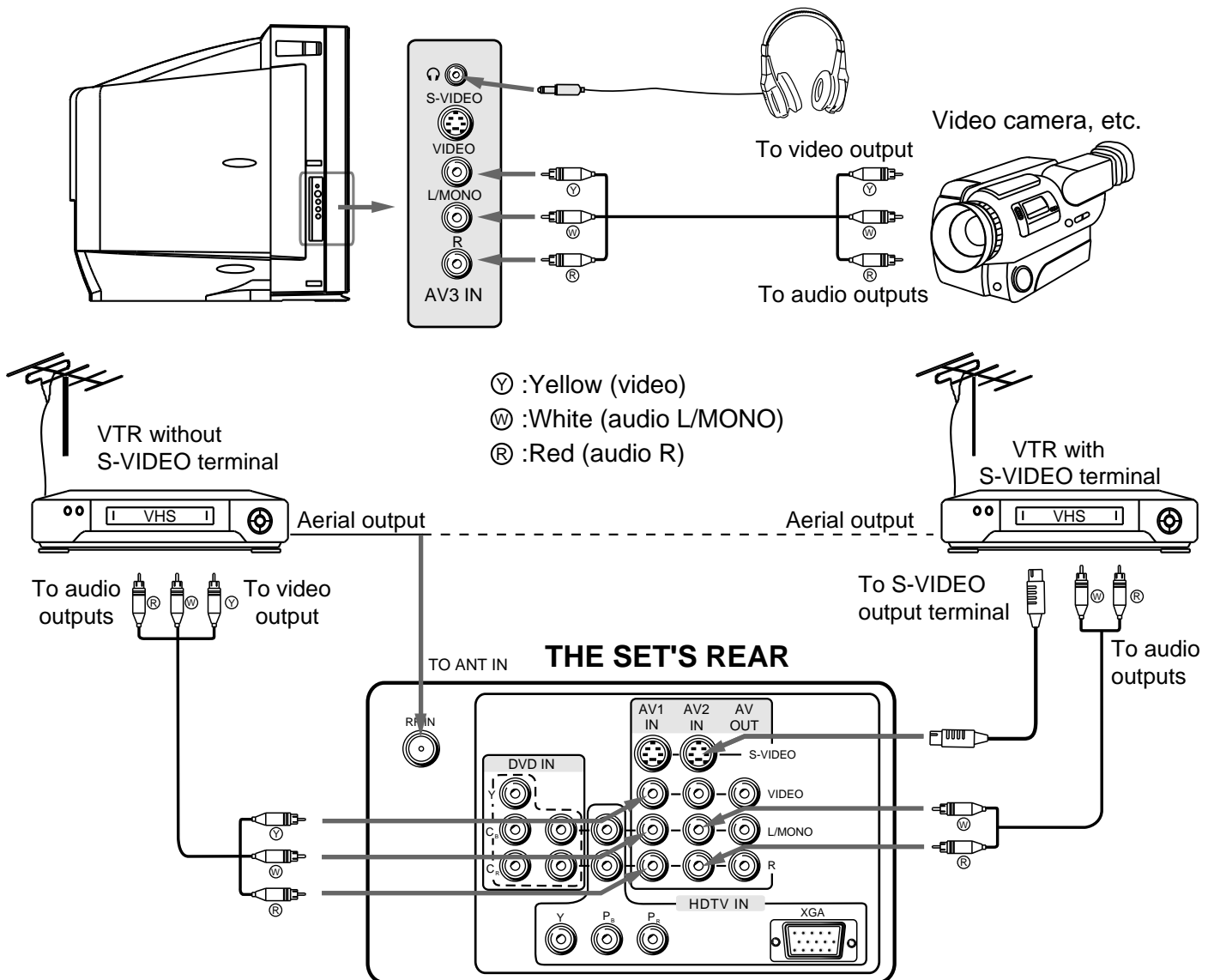

To select the input, press **AV/TV** button to display the signal source selection menu and press the **CH ▲** or **CH ▼** button to select the corresponding input mode (AV1 or AV2 or AV3) and press **VOL ►** button to confirm.

Note on the S-VIDEO terminal

The S-VIDEO input terminal has priority over the AV1, AV2 VIDEO terminals on the rear and the AV3 VIDEO terminal on the side. To use equipment connected to the video terminals, disconnect any plug from the S-VIDEO terminal.

Installation (continued)

External equipment connections (continued)

2. To connect DVD input terminals

The figure below shows how to connect the DVD input terminals of the TV set to the DVD Player, Laser Disk Player, etc.

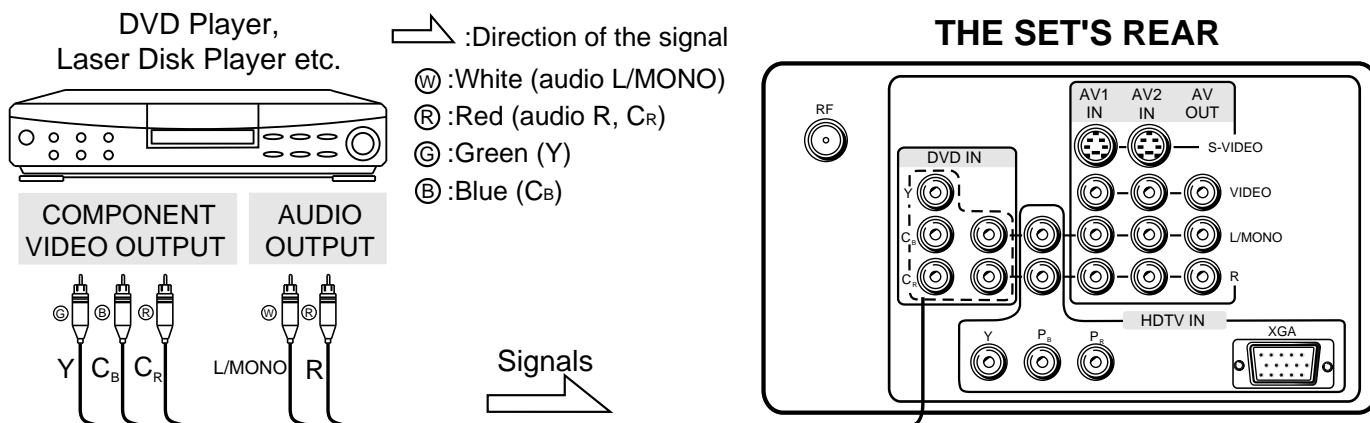

Press **AV/TV** button to display the signal source selection menu and select **YCbCr** mode. The picture shown on the screen is the program from the DVD Player.

Note: Both the component video Cr terminal and the audio R terminal are red for easy identification. Make sure these are correctly connected.

3. To connect AV output terminals

You can connect a stereo system to the audio output terminals (phono type) on the set to enjoy a high-quality sound from the stereo system. You can also connect AV output terminals to VTR to record programs being displayed on the screen (Note: Only when the signal source is input through RF or AV1 IN or AV2 IN or AV3 IN, there is signal for AV OUT terminals to output).

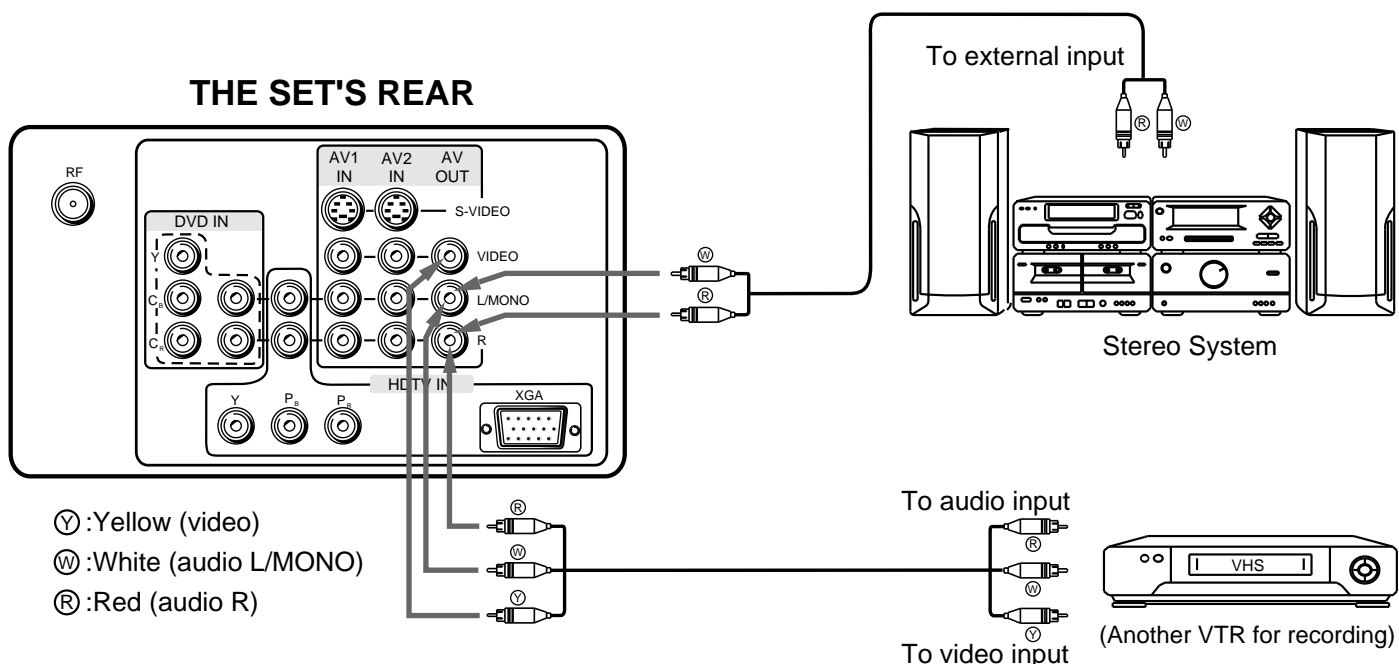

4. To connect XGA input interface

The figure below shows how to connect the set to the computer through XGA interface.

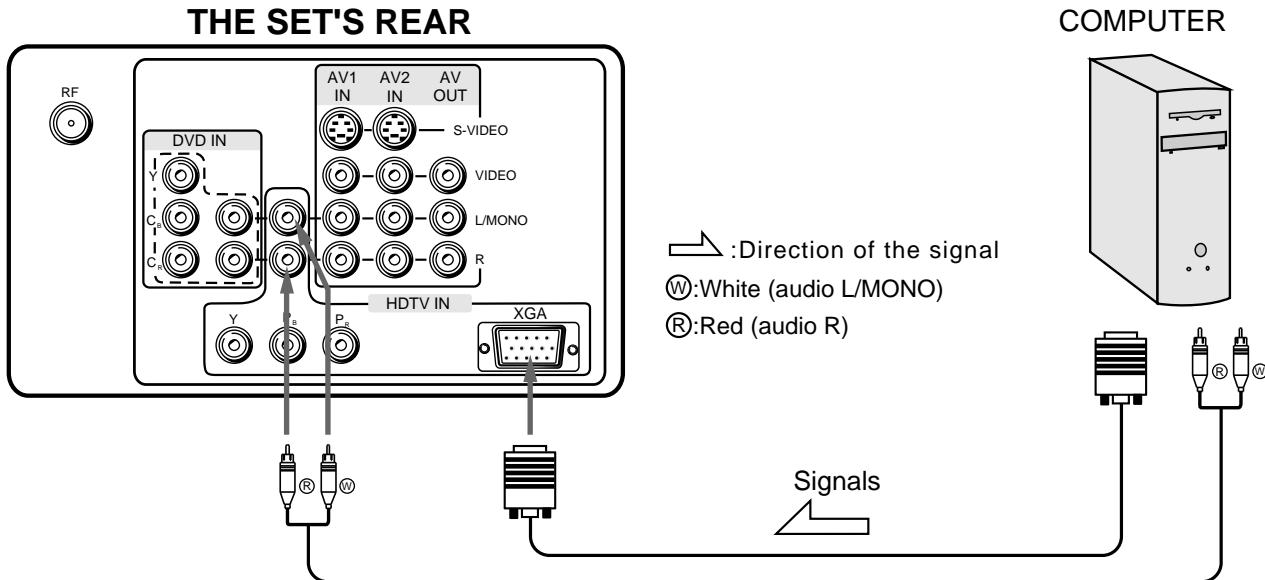

Press **AV/TV** button to display the signal source selection menu and select **XGA** mode. At this time the screen will display information from the computer.

5. To connect HDTV set top box

If your HDTV set top box is incorporated with YPbPr terminals, connect the set top box to the TV set through the YPbPr terminals, connect audio lines from set top box to HDTV IN L/R sound inputs, note that L to Land R to R.

(If your set top box is incorporated with XGA interface, please connect according to "**To connect XGA input interface**" which is shown above).

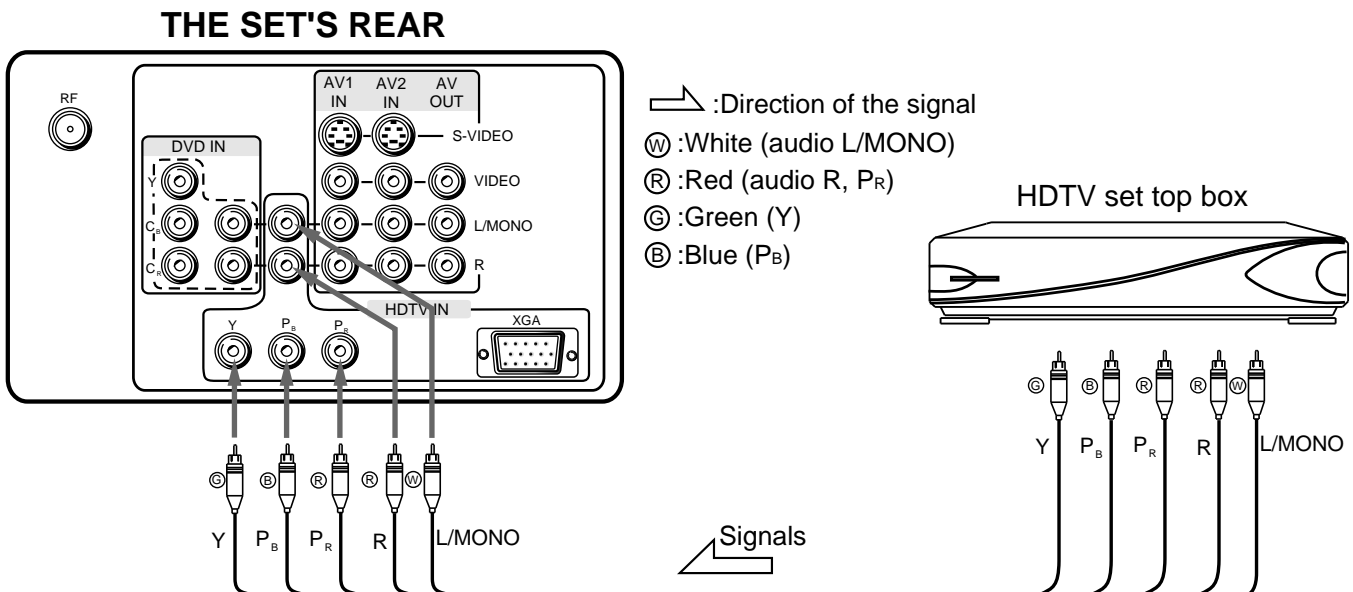

Press **AV/TV** button to display the signal source selection menu and then select **YPbPr** mode. Now you can view programs play backed by the set top box.

Basic Operations

Turning on/off & Signal source selection

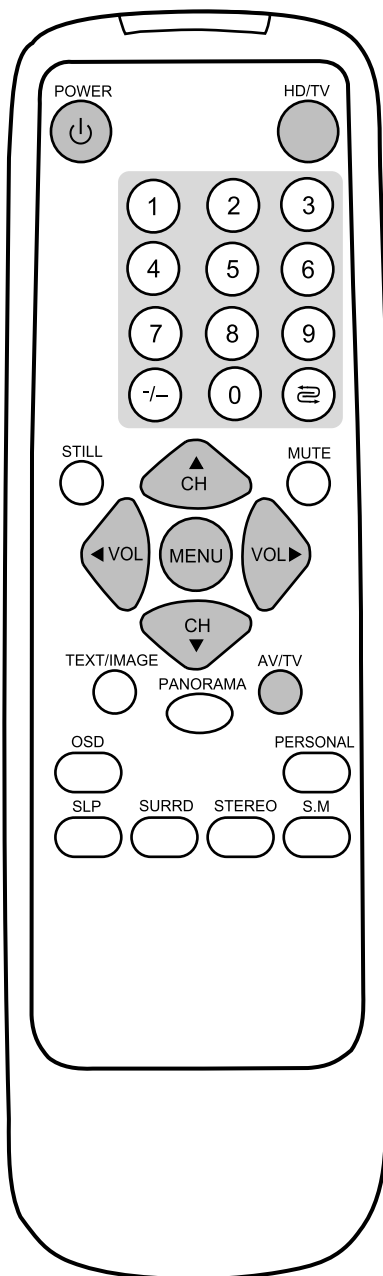

Turning on

- 1 Press the main **POWER SWITCH**, the red power indicator lights up, the set is in standby mode.
- 2 Press the **POWER** button on the remote controller to turn on the set, and the power indicator turns to yellow. Or you can directly press **Channel up/down** button on the set to turn on the set.

Turning off

- 1 To turn off the set completely, press the main **POWER SWITCH**.
- 2 To turn off the set temporarily, press the **POWER** button on the remote controller, the set is in standby mode, the indicator turns to red.

! Note:

If **Power Restore** item in **OPTION** sub-menu is set to **ON**, next when you press Power Switch to turn on, the TV will directly be in **Power On** mode.

Even if you set **Power Restore** to **OFF** while you quickly switch off/on the TV the TV will also be in **Power ON** mode directly.

Signal source selection

- 1 Press the **AV/TV** button to display signal source selection menu.
- 2 Press the **CH▲** or **CH▼** button to select one of RF/AV1(SAV1)/AV1(SAV2)/AV3(SAV3)/YCbCr/XGA/YPbPr.
- 3 Press **VOL◀** or **VOL▶** button to confirm your choice.

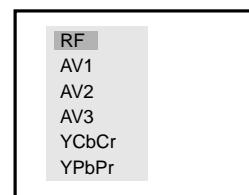

If you select XGA or YPbPr as signal source, later on you can directly press **HD/TV** button to switch between the previous viewing mode (RF or VIDEO mode) and HDTV mode.

! Note:

When the remote operation is received by the set, the **TIMER** indicator (green) on the set's front will glitter to inform the user.

The buttons in this manual refer to the ones on the remote controller if without special indication.

Menu introduction

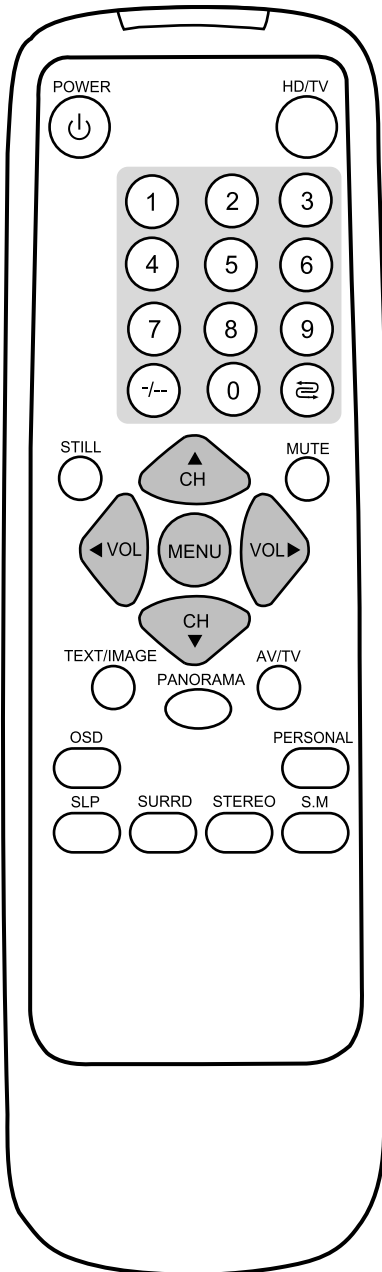

Menu introduction

- 1 Press **MENU** to enter into menu mode.
- 2 Press **VOL<** or **VOL>** to select menu icon.
- 3 Press **CH▼** to enter into the menu.
- 4 In menu operation, use **CH▲/▼** to select and **VOL </>** to adjust.
- 5 To exit menu mode, press **MENU** button.

Below is a menu overview in RF (TV) mode.

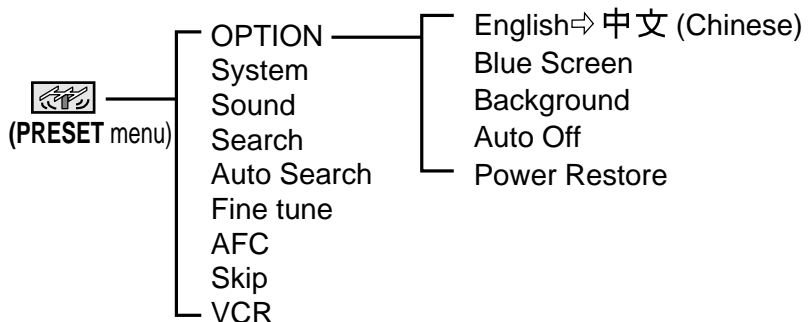
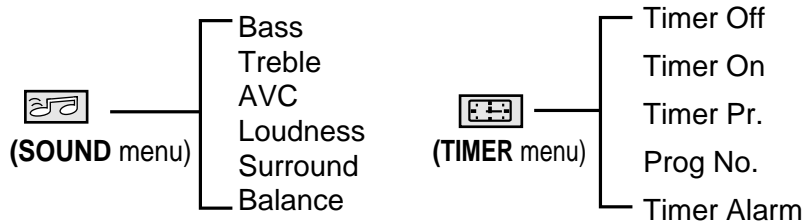
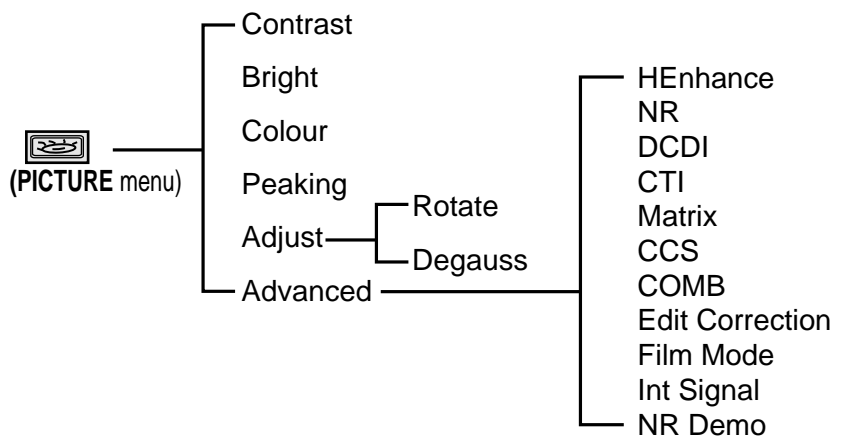

Operations in RF mode

Channel Presetting

Auto search/Manual search

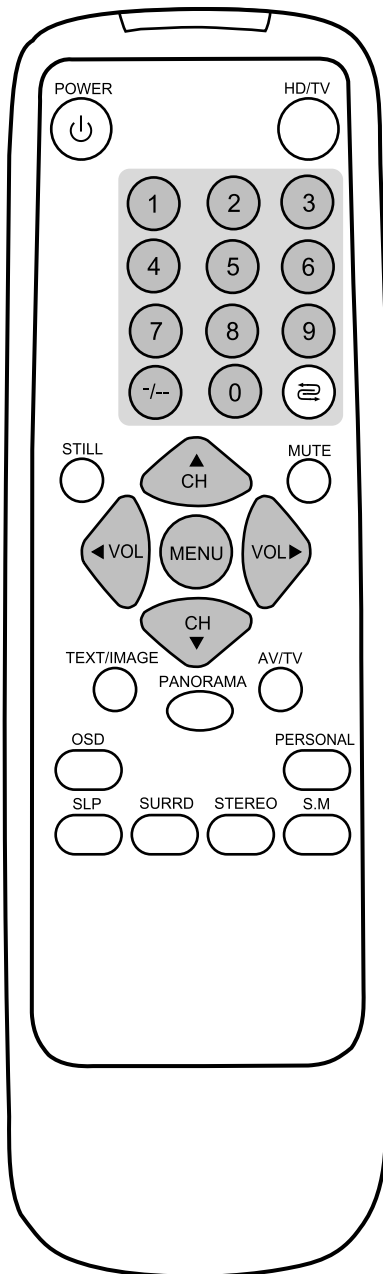

If you have preset the channels, you can directly watch TV programs after turning on the set. If not, then preset channels in one of the following ways.

Auto search

- 1 Press **MENU** button.
- 2 Press **VOL**◀ or **VOL**▶ to select **PRESET** menu icon, press **CH**▼ to enter into **PRESET** menu.
- 3 Press **CH**▼ repeatedly to select Auto Search.
- 4 Press **VOL**◀ or **VOL**▶ to start auto search. All active channels will be searched and stored into the memory automatically. After auto search, the TV will return to the initial channel program.

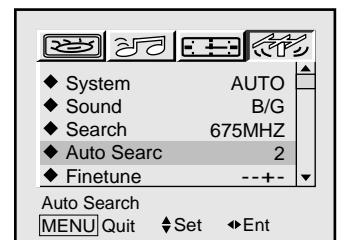
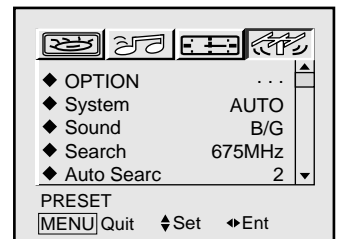

During auto search, pressing **MENU** button can exit.

Manual search

If auto search can not preset the desired channels, or you want to preset the desired channels one by one with the preferred channel number, please make use of **Search**.

- 1 Use channel select buttons to select a channel number.
- 2 Enter into the **PRESET** menu, press **CH**▲/▼ button to select **Search**.
- 3 Press **VOL**◀ or **VOL**▶ button to start searching. When a channel is located, the searching stops, this channel is then memorised with the preset channel number. If the channel is not the one you desire, please keep pressing **VOL**◀ or **VOL**▶ button until you get the desired channel.

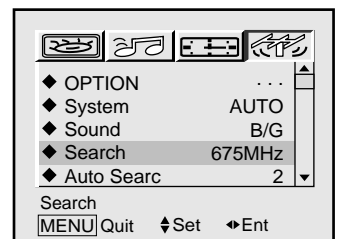

The setting of colour and sound system

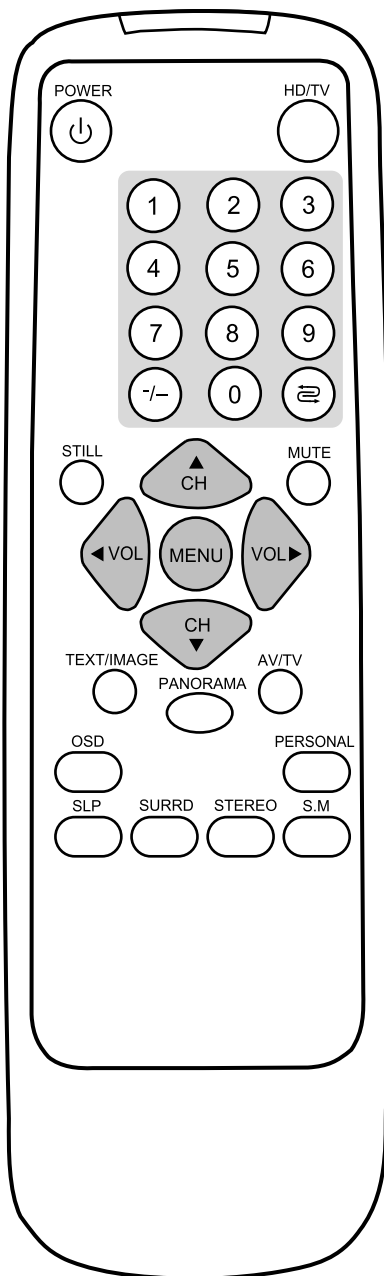

The setting of colour and sound system

If the colour or sound of a certain channel is abnormal, the colour or sound system setting may be incorrect. Please do the following to change the system setting. (You may press **OSD** button to check whether the colour or sound system is correct)

• When the colour of the picture is abnormal

- 1** Enter into **PRESET** menu.
- 2** Press **CH ▲/▼** to select **SYSTEM** menu item.
- 3** Press **VOL ◀/▶** to select the correct colour system.

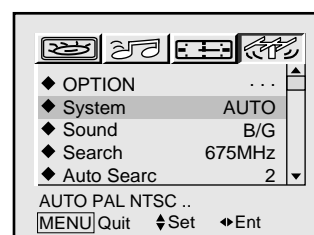

AUTO, PAL, SECAM, PAL-N, NTSC, N443, PAL60 and PAL-M will appear cyclically.

In normal circumstances, please set the colour system to AUTO, and the set can automatically select the proper colour system. If colour is still abnormal, then select the proper colour system manually.

• When the sound is abnormal

- 1** Enter into **PRESET** menu.
- 2** Press **CH ▲/▼** to select **Sound** menu item.
- 3** Press **VOL ◀/▶** to select the correct sound system.

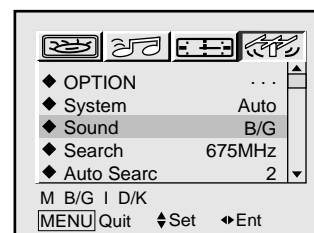

M, B/G, I, D/K will appear cyclically.

Channel Presetting

Fine tuning

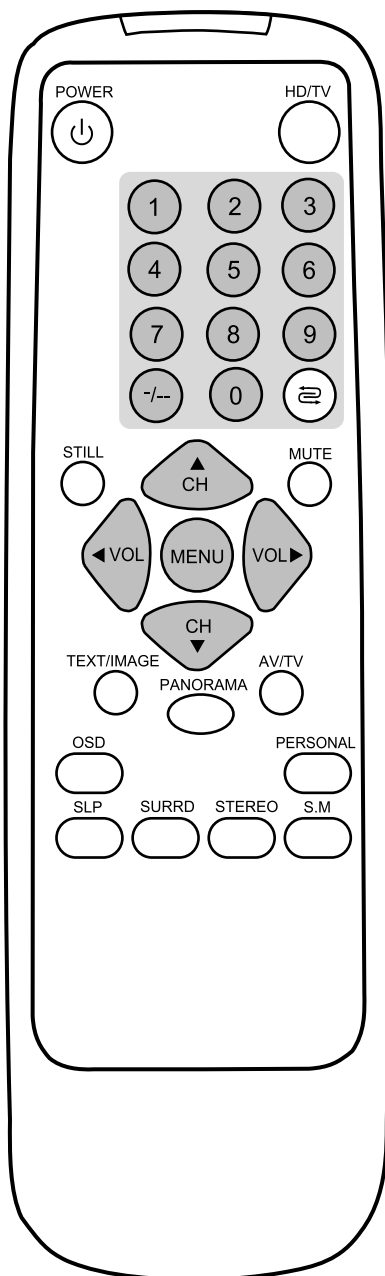

When picture and sound's effect of a channel is poor (for example, one or two CATV channel's picture and sound are not standard), you can correct them by making use of Fine Tuning.

AFC (Auto Frequency Control)

- 1 Select the channel you want to fine-tune.
- 2 Enter into the **PRESET** menu.
- 3 Press **CH ▲/▼** button to select **AFC**.
- 4 Press **VOL ◀/▶** button to select **AFC ON** to activate it, the set begins fine-tune until the optimum picture and sound is achieved.

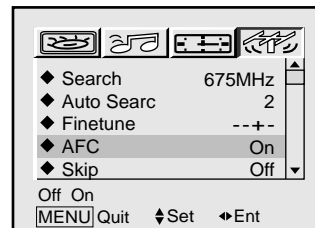

To use **AFC** is recommended. If you are not satisfied with the effects after the **AFC**, you can shut down **AFC** and make use of **FINETUNE** until you get satisfied effect.

Fine tune

- 1 Select the channel you want to fine-tune.
- 2 Enter into the **PRESET** menu.
- 3 Press **CH ▲/▼** button to select **Finetune**.
- 4 Press and hold **VOL ◀/▶** button to begin fine-tune until the optimum picture and sound is achieved.

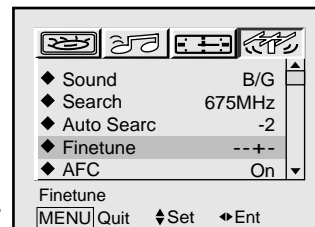

Note: if some channel's colour or sound is still abnormal, it may be that the setting of the colour or the sound system is wrong, please do adjustment according to "**The setting of colour and sound system**" to set the proper colour and sound system.

To skip unnecessary channels/VCR

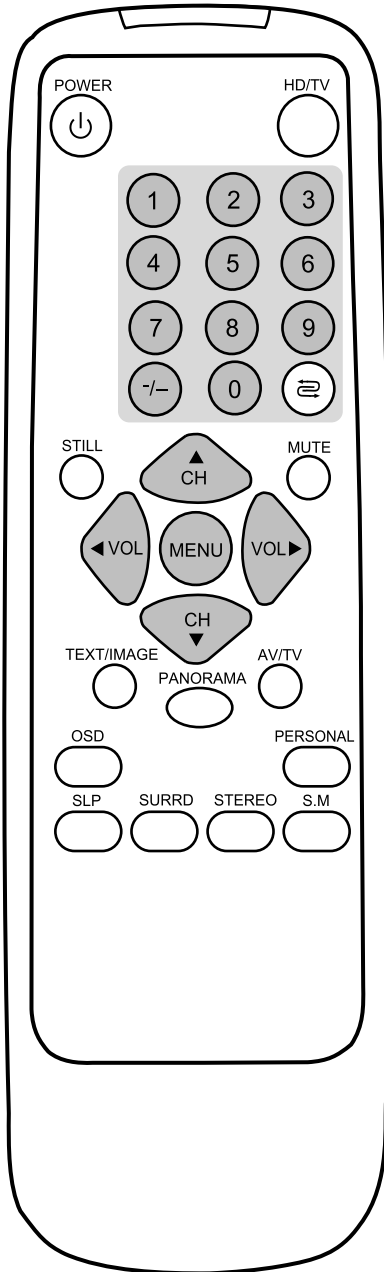

To skip unnecessary channels

After presetting the channels, you can skip unnecessary channels so that only the channels you want to watch are selected with **Channel up/down** button.

- 1 Select the channel you want to skip.
- 2 Enter into **PRESET** menu.
- 3 Press **CH ▲/▼** to select **Skip** menu item.
- 4 Press **VOL ◀/▶** to set **SKIP ON**.

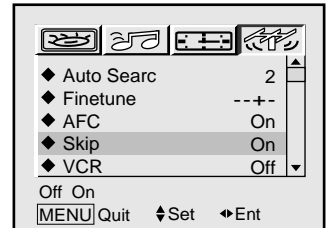

Thus, when you select channels with **Channel up/down** button, this channel will then be skipped.

To restore a skipped channel, select the channel you want to restore with the number buttons, enter into the **PRESET** menu to set **SKIP** to **OFF**.

VCR

When receiving **VCR**-type programs, there may occur a jump of the picture or bend of upper picture. You can solve this problem by activating **VCR** function. Please do the following steps:

- 1 Enter into **PRESET** menu.
- 2 Press **CH ▲/▼** to select **VCR** menu item.
- 3 Press **VOL ◀/▶** to set **VCR** to **ON**.

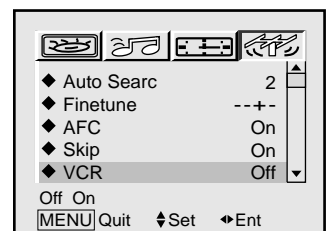

If you do not meet this problem, or the program is not VCR-type program, please shut off this function.

Channel Selection

Channel selection

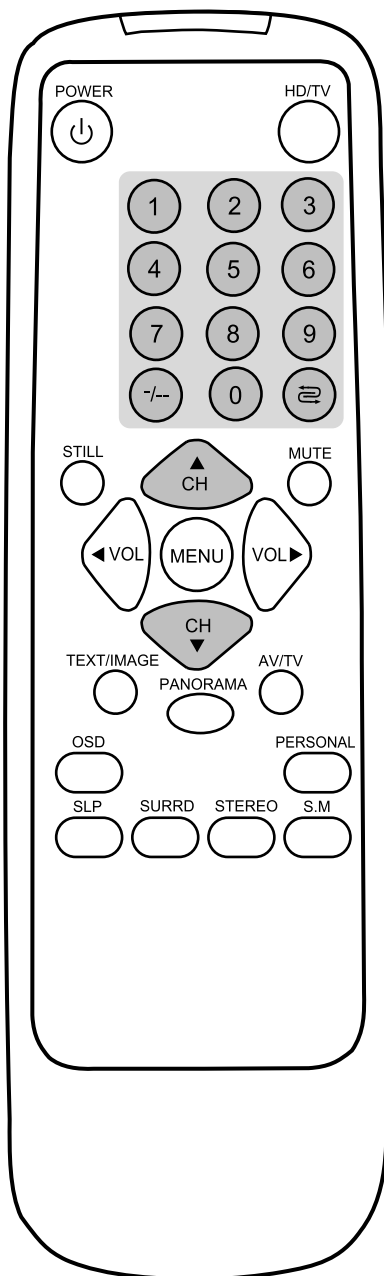

Using the direct select buttons

- To select a one-digit channel

- 1 Press -/-- button to display "--" on the top right screen.
- 2 Press 0-9 number buttons to select a channel.

- To select a two-digit channel

- 1 Press -/-- button to display "--" on the top right screen.
- 2 Press 0-9 number buttons to select a channel.

- To select a three-digit channel

- 1 Press -/-- button to display "---" on the top right screen.
- 2 Press 0-9 number buttons to select a channel.

Using the Channel up/down buttons

Press **CH▲** to select higher channel numbers;
CH▼ to select lower ones.

Using the PREVIOUS channel button

Press the  button on the remote controller can swap the current viewed channel with the previous one.

Note:

Pressing the  button can also switch between programs from RF, AV1, AV2, AV3, DVD IN, HDTV IN.

Picture adjustment

Picture adjustment

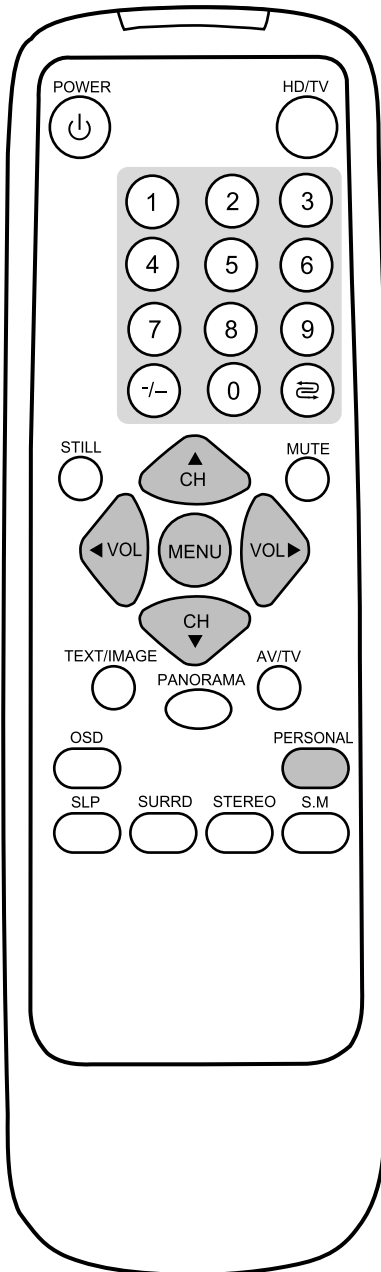

Making use of PERSONAL button

You can select the picture quality instantly among three preset modes and one user-set mode.

Press the **PERSONAL** button to select the desired picture quality. **Standard, Soft, Bright** and **Personal** (user-set) can be selected cyclically.

In these settings, brightness and contrast are different. You can select one of them to fit different environment and the program type. The picture quality you have set in PICTURE menu will be stored into **Personal**.

Making use of PICTURE menu

- 1 Press **MENU** button.
- 2 Press **VOL** ◀ or **VOL** ▶ to select **PICTURE** menu icon, press **CH** ▼ to enter into **PICTURE** menu.
- 3 Press **CH** ▲/▼ to select the desired adjustment item.
- 4 Press **VOL** ◀ or **VOL** ▶ to adjust.

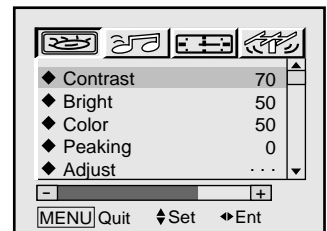
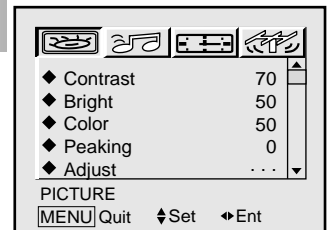

Option	Function	Operation	Range
Contrast	Adjusts image contrast.	VOL ◀ :stronger VOL ▶ :weaker	0-100
Bright	Adjusts screen brightness for easier viewing of dark picture such as night scenes and black hair.	VOL ◀ :lighter VOL ▶ :darker	0-100
Color	Adjusts colour saturation.	VOL ◀ :deeper VOL ▶ :paler	0-100
Peaking	Adjusts image sharpness and displays a sharp image.	VOL ◀ :sharper VOL ▶ :softer	0-10
TINT	Adjusts for nice skin colour.	VOL ◀ :greenish VOL ▶ :purplish	-50 - 50

! **Note:** TINT is only for NTSC system.

Picture adjustment (continued)

Picture adjustment

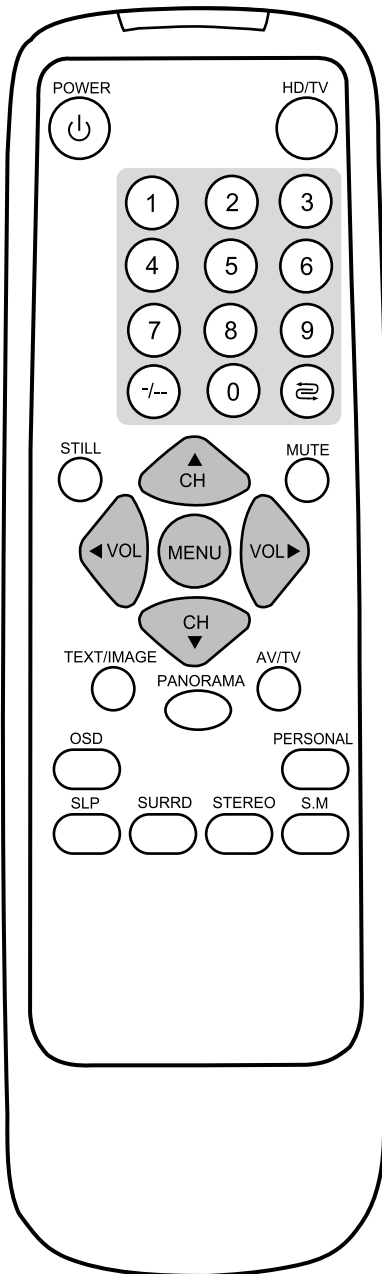

Picture Rotate

When you switch on your TV, there may be a slight tilt of the picture to the left or right. This is due to the earth's magnetic field or position of your TV. To rectify, you can do the following.

- 1 Enter into **PICTURE** menu.
- 2 Press **CH ▲/▼** to select **Adjust** menu item.
- 3 Press **VOL ◀** or **VOL ▶** to enter into the sub-menu.
- 4 Press **CH ▲/▼** to select **Rotate**.
- 5 Press **VOL ◀** or **VOL ▶** to rotate the picture leftward or rightward until you rectify it.

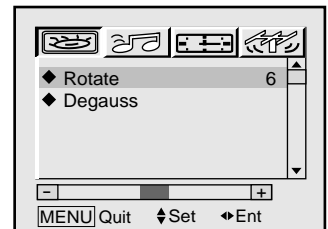
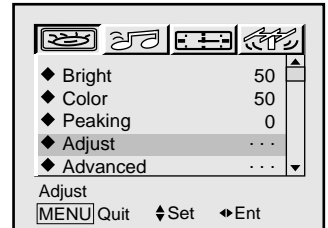

Degaussing

If there occurs magnetisation, please do the following to degauss the set:

- 1 Enter into **PICTURE** menu and select **Adjust** menu item.
- 2 Press **VOL ◀** or **VOL ▶** to enter into the sub-menu.
- 3 Press **CH ▲/▼** to select **Degauss**.
- 4 Press **VOL ◀** or **VOL ▶** button, the degaussing circuit begins to work. If still can not degauss thoroughly, please repeat the above operation after 15-20 minutes until magnetisation disappear.

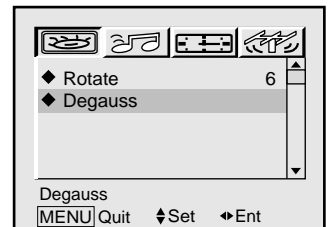

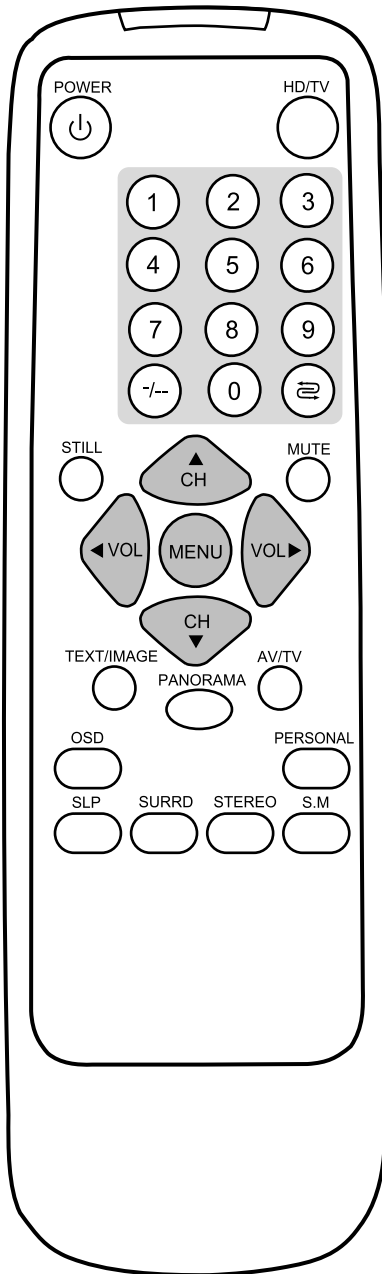

To adjust Advanced menu item

- 1 Enter into **PICTURE** menu.
- 2 Press **CH ▲/▼** to select **Advanced** menu item.
- 3 Press **VOL ◀** or **VOL ▶** to enter into the sub-menu.
- 4 Press **CH ▲/▼** to select item.
- 5 Press **VOL ◀** or **VOL ▶** to adjust.

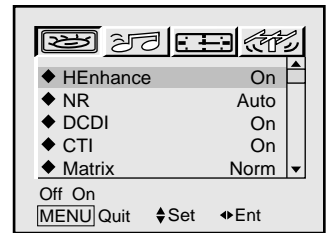
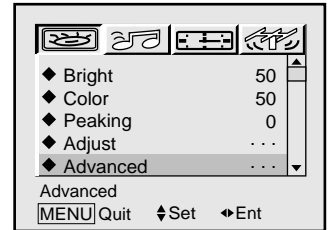

Option	Function	Operation	Range
HEnhance	Enhances horizontal details.	Use VOL ◀/▶ to toggle	On or Off
NR	Reduces picture noise.	Use VOL ◀/▶ to toggle	Off/Low/Mid/High/Auto
DCDI	Directional Correlational Deinterlacing.	Use VOL ◀/▶ to toggle	On or Off
CTI	Colour transient improver.	Use VOL ◀/▶ to toggle	On or Off
Matrix	Changes input colour matrix.	Use VOL ◀/▶ to toggle	Warm/Cold/Normal
CCS	Cross colour suppressor.	Use VOL ◀/▶ to toggle	On or Off
COMB	Comb filter for YIC separation.	Use VOL ◀/▶ to toggle	On or Off
EditCorr	Edit correction for program in FilmMode.	Use VOL ◀/▶ to toggle	On or Off
FilmMode	Some movies are edited in filmmode. In this case, turn on FilmMode.	Use VOL ◀/▶ to toggle	On or Off
IntSignal	Internal Signal.	Use VOL ◀/▶ to toggle	Off / 0 / 1 / 2
NRDemo	Picture noise reduction demonstration.	Use VOL ◀/▶ to toggle	On or Off

! Note:

When watching moving pictures, do not set **NR** to **MID** or **HIGH**, otherwise the receiving effects will be affected.

There is no **COMB** item when in YCbCr or S-VIDEO input mode.

Picture adjustment *(continued)*

Picture adjustment

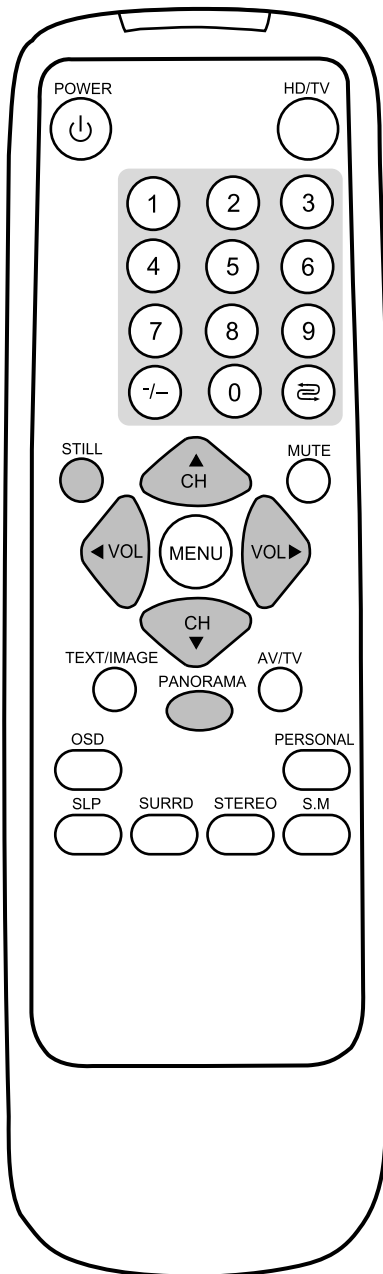

Picture stillness

Press **STILL** button to still the current picture, press it again to restore.

Stillness

Adjusting screen aspect

- 1 Press **PANORAMA** button.
- 2 Press **CH ▲/▼** to select a screen aspect ratio.

16:9
4:3
Panorama
Zoom 5

16:9/4:3/Panorama/Zoom can be selected.

16:9 mode expands the conventional 4:3 picture into a full 16:9 picture and at the same time still maintains the height of the picture. Or view DVD program, movie in 16:9 mode.

4:3 mode leaves conventional 4:3 picture as they are, with black bars on both sides of your screen.

Note: In **4:3 display mode**, when the current picture's brightness changes largely, there occurs blurry and tingling on picture's left and right sides, or when picture's upper and lower part's brightness differs greatly, there is tilt on picture's sides, these are normal phenomena, it is not necessary to worry about them.

PANORAMA mode expands the conventional 4:3 picture into a full 16:9 picture and at the same time still maintains a good aspect ratio at the centre of the screen. This will minimise distortion and produce a remarkable panoramic picture.

Zoom mode is recommended for viewing "letter-box" movie (picture with a black bar on the top and bottom) with 16:9 format. When you select this mode, you are able to fill up the whole screen. If you watch a 4:3 picture in this mode, the picture will be expanded and some information at the top and bottom will be lost.

In **Zoom mode**, you can pan the picture upward or downward by using **VOL ◀/▶** button.

Sound adjustment

Sound adjustment

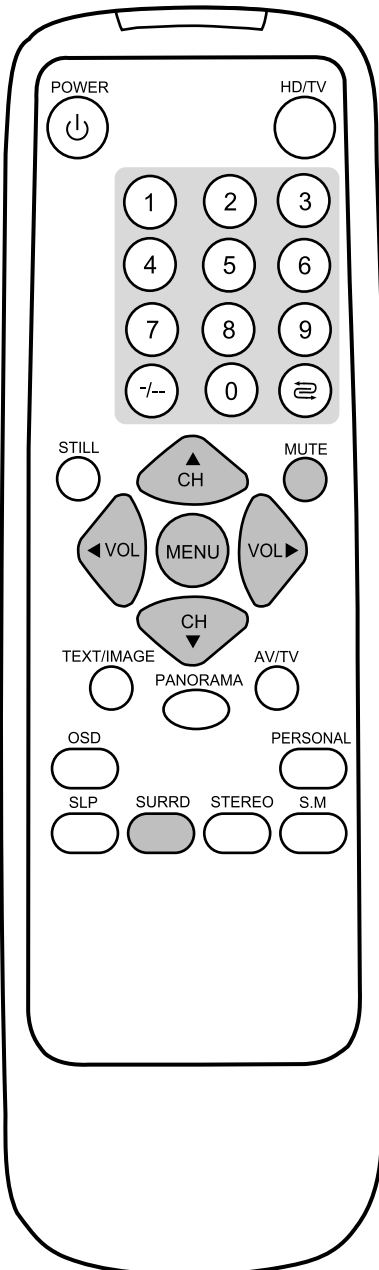

Volume adjustment

Press the **VOL◀** or **VOL▶** to increase or decrease the volume.

Sound mute

Press **MUTE** button to mute the sound temporarily and press it again to restore the sound.

Mute

Sound adjustment

- 1 Press **MENU** button.
- 2 Press **VOL◀** or **VOL▶** to select **SOUND** menu icon, press **CH▼** to enter into **SOUND** menu.
- 3 Press **CH▲/▼** select the desired adjustment item.
- 4 Press **VOL◀** or **VOL▶** to adjust.

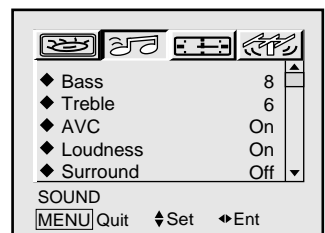

Option	Function	Operation	Range
Bass	Adjusts low sounds	VOL▶ :stronger VOL◀ :weaker	-10 - 10
Treble	Adjusts high sounds	VOL▶ :stronger VOL◀ :weaker	-10 - 10
AVC	Auto volume control. (Keeps the volume when you change channels)	Use VOL◀/▶ to toggle	On/Off
Loudness	Lets the ears enjoy enough bass and treble even if the volume is lower.	Use VOL◀/▶ to toggle	On/Off
Surround	Adjusts surround sound effect	Use VOL◀/▶ to toggle	Off/Low/High
Balance	Adjusts left and right volumes	VOL▶:decreases the left channel VOL◀:increases the right channel	-10 - 10

Surround sound function

The benefits of surround sound are enormous. You can be completely enveloped in sound, just as if you were at a concert hall or cinema.

You can make use of **Sound** menu to select surround sound setting, or directly press **SURRD** button, **Off/Low/High** can be selected.

Surround High

Sound adjustment *(continued)*

Sound adjustment

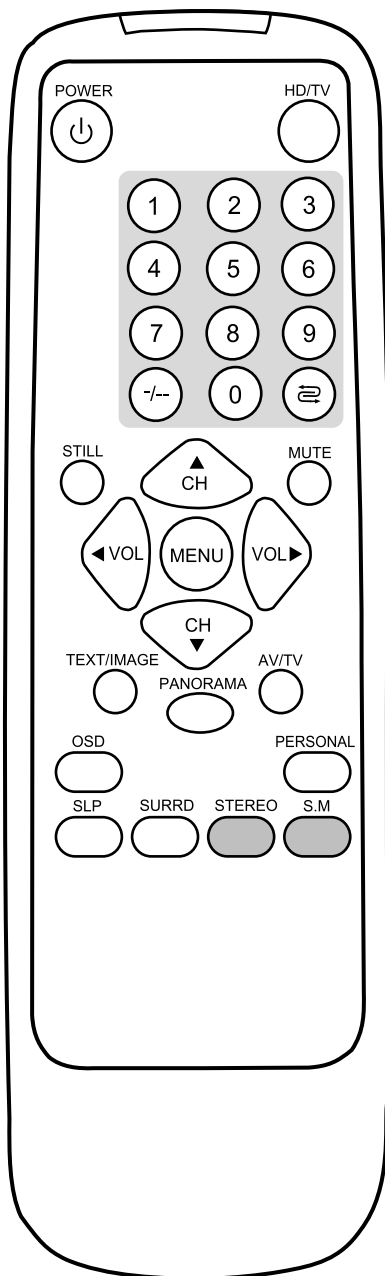

Stereo function

This set can identify stereo program. If you are receiving stereo program and you want to get stereo effect, please press **STEREO** button on the remote controller to select **Stereo**. Press the **STEREO** button again the set will restore to **FM Mono** mode. If the program is an ordinary one without stereo, pressing this button has no effect.

Stereo

Preset sound mode selection

Press the **S.M** button to quickly select sound mode.

There are four preset sound modes (**Standard**, **News**, **Hall** and **Music**) and one user-set sound mode (**Personal**). Each preset mode has its own sound setting.

Standard: standard sound.

News: suitable for listening to news/dialogue.

Hall: like a concert hall filled with a rich warm sound.

Music: suitable for listening to music.

Personal: the sound quality you set.

Standard

Timer setting

Timer setting

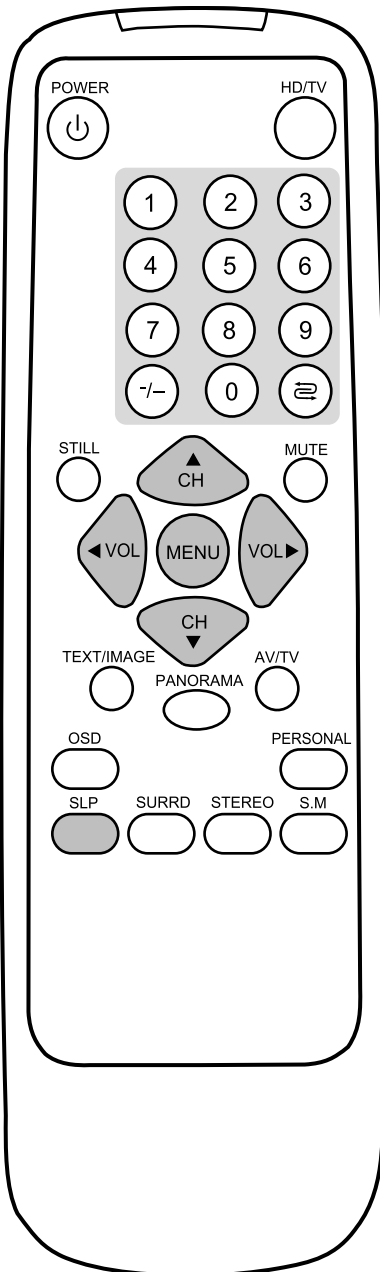

Making use of Sleep timer function

You can make use of Sleep timer function to turn off the set automatically after a preset time, and bring the set to standby mode.

Press **SLP** button, the screen will display **Timer Off 00: 00: 00**. Press **VOL ◀** or **VOL ▶** button to change sleep time. To cancel sleep timer function, press **VOL ◀** or **VOL ▶** button repeatedly until the screen displays **00: 00: 00**.

Timer Off 00: 00: 00

Making use of TIMER menu

- 1 Press **MENU** button.
- 2 Press **VOL ◀** or **VOL ▶** to select **TIMER** menu icon, press **CH ▼** to enter into **TIMER** menu.
- 3 Press **CH ▲/▼** to select item.
- 4 Press **VOL ◀** or **VOL ▶** to set.

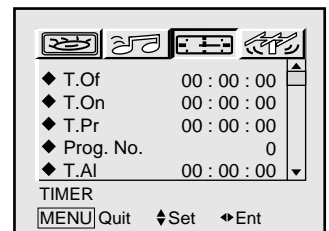

Option	Function	Remarks
Timer Off	To turn off the TV automatically at a preset time.	To cancel the function, set it to 00: 00: 00
Timer On	To turn on the TV automatically at a preset time.	To cancel the function, set it to 00: 00: 00
Timer Pr.	To switch to a preset channel automatically at a preset time.	To cancel the function, set it to 00: 00: 00
Prog No.	To set a program number for Timer Pr.	
Timer Alarm	To alarm automatically at a preset time.	To cancel the function, set it to 00: 00: 00

Once you set the ON timer, the green ON-timer indicator will light up on TV front.

System setup

System setup

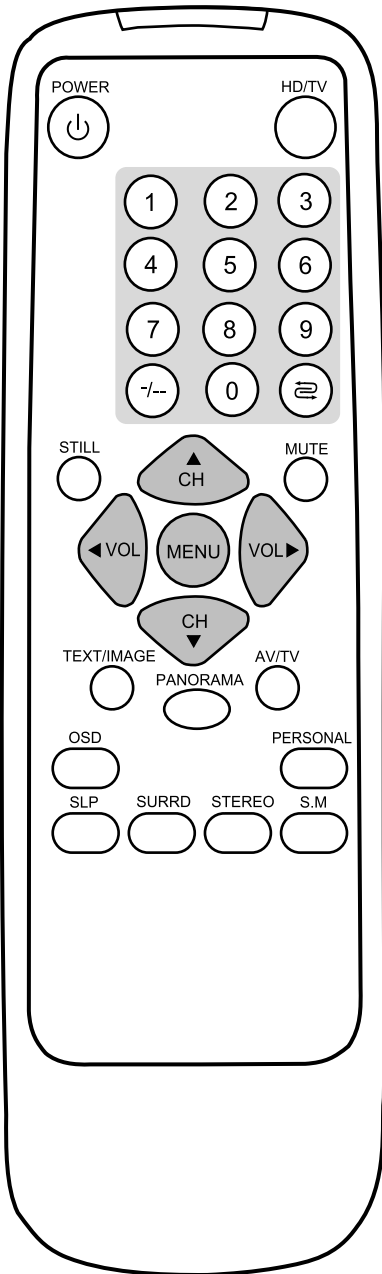

To select the language for the OSD

Use this function to switch the language for the OSD to either English or Chinese. Please do the following steps:

- 1 Press **MENU** button.
- 2 Press **VOL**◀ or **VOL**▶ to select **PRESET** menu icon, press **CH**▼ to enter into **PRESET** menu.
- 3 Press **CH**▲/▼ to select **OPTION** menu item, press **VOL**◀ or **VOL**▶ to enter into the sub-menu.
- 4 Press **CH**▲/▼ to select the first menu item, press **VOL**◀ or **VOL**▶ to select the desired language.

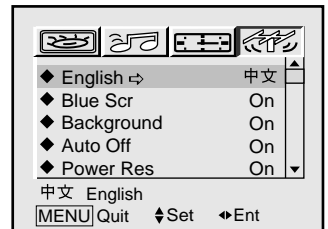
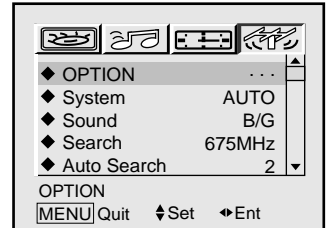

The selected language is displayed in front and the screen menu is automatically displayed in that language.

Blue screen

With the blue screen function ON, the TV will automatically turn blue when no signal is being received. Otherwise it will display snowy picture.

- 1 Enter into **OPTION** sub-menu.
- 2 Press **CH**▲/▼ to select Blue Screen menu item.
- 3 Press **VOL**◀ or **VOL**▶ to change the blue screen setting On or Off.

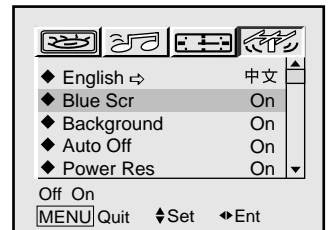

Setting the menu background

Use this function to set the menu background to either blue or transparent.

- 1 Enter into **OPTION** sub-menu.
- 2 Press **CH**▲/▼ to select Background menu item.
- 3 Press **VOL**◀ or **VOL**▶ to change the menu background setting On (blue) or Off (transparent).



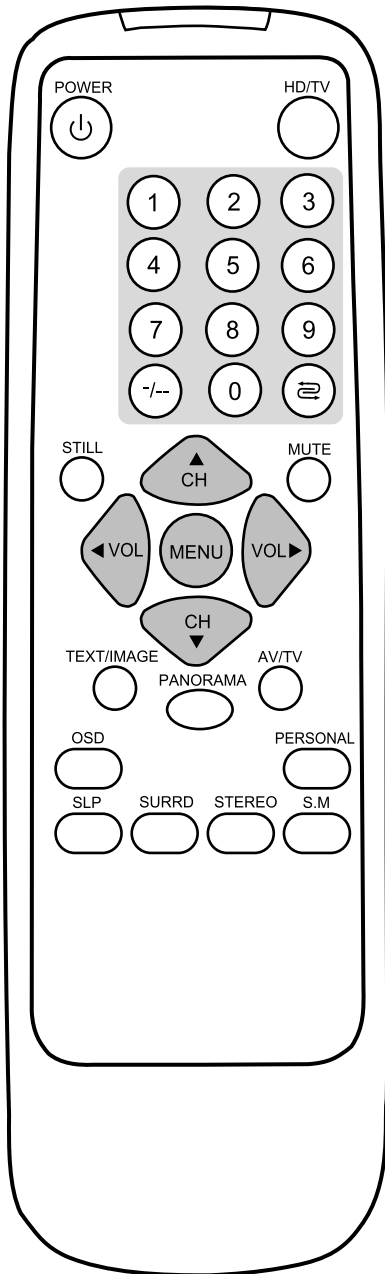

Auto-Power-Off function

With Auto-Power-Off function ON, the TV will automatically turn off after about 5 minutes when no signal is being received.

- 1 Enter into **OPTION** sub-menu
- 2 Press **CH▲/▼** to select **Auto Off** menu item.
- 3 Press **VOL◀** or **VOL▶** to change the Auto Off setting On or Off.



Note: If you set Auto Off to OFF, it will not automatically turn off when no signal is being received.

Power Restore function

- 1 Enter into **OPTION** sub-menu.
- 2 Press **CH▲/▼** to select **Power Restore** menu item.
- 3 Press **VOL◀** or **VOL▶** to set On or Off.



If you set **Power Restore** to **OFF**, then you turn off the TV by Power Switch, next when you press the Power Switch, the TV will be in **Standby** mode.

If you set **Power Restore** to **ON**, then you turn off the TV by Power Switch, next when you press the Power Switch, the TV will be in **Power On** mode directly.

Operation in Video mode

(AV1/AV2/AV3/YCbCr)

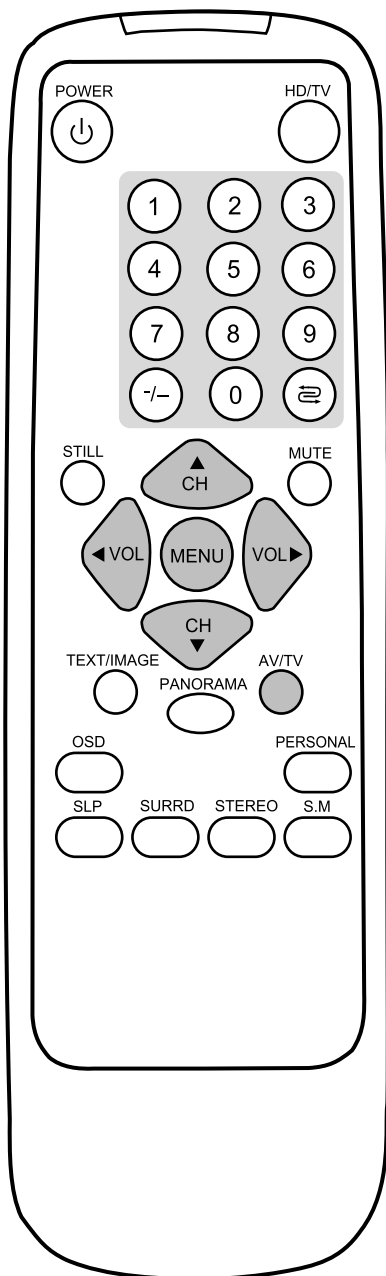

You can connect video equipments such as a VDC, VCR, DVD to this TV and enjoy the program play-backed by the video equipment.

Press the **AV/TV** button to display the signal source selection menu and then select corresponding video mode.

As regards to the menu operation and menu item adjustment in video mode, please refer to **Operation in RF mode**.

Note:

In video mode, it is unnecessary to preset some menu items, so these unnecessary menu items are not displayed.

Operations in HDTV mode

1. YPbPr mode

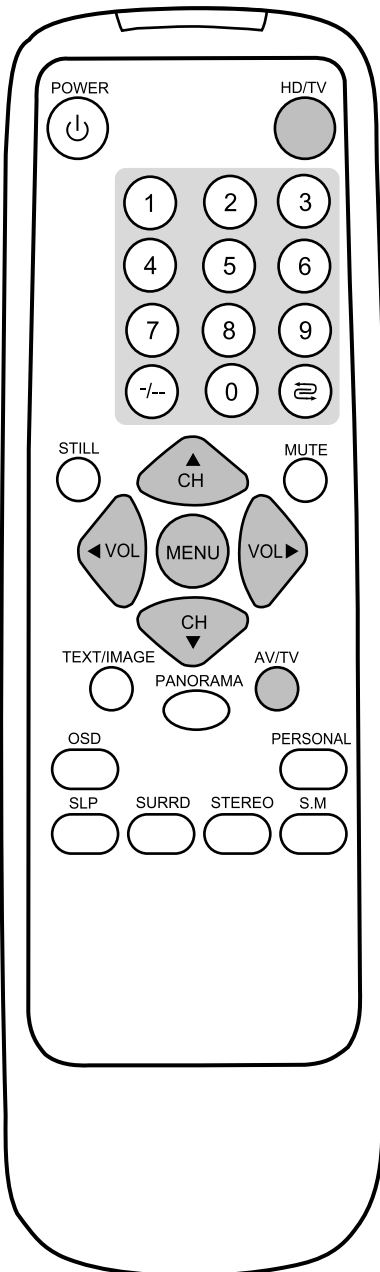

When the signal source is input through YPbPr terminals, then the set will work in HDTV mode.

Connect PDVD or HDTV set top box to the TV through YPbPr terminals. (Refer to **Installation** on page 10.)

Firstly please press **AV/TV** button to call up the signal source selection menu and then select **YPbPr** mode.

Later on you can directly press **HD/TV** button to switch between the previous viewing mode (RF or VIDEO mode) and HDTV mode.

As regards to the menu operation and menu item adjustment in YPbPr mode, please refer to **Operation in RF mode**.

In YPbPr mode, it is unnecessary to preset some menu items, so these unnecessary menu items are not displayed.

In YPbPr mode, the **Adjust** sub-menu in PICTURE menu is different. Below we will introduce this sub-menu.

Making use of the Adjust sub-menu to adjust picture

- 1** Enter into **PICTURE** menu.
- 2** Press **CH ▲/▼** to select **Adjust** menu item.
- 3** Press **VOL ◀** or **VOL ▶** to enter into the submenu.
- 4** Press **CH ▲/▼** to select item.
- 5** Press **VOL ◀** or **VOL ▶** to adjust.

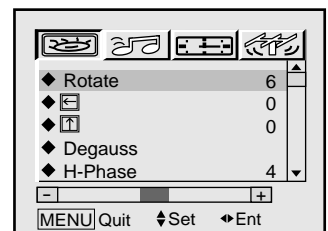
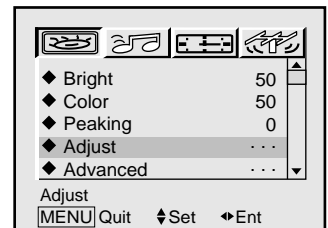

Option	Function	Operation	Range
Rotate	Rotates the picture leftward or rightward	Use VOL ◀/▶ to rotate	-50 - 50
	Adjusts picture position horizontally.	VOL ▶ :rightward VOL ◀ :leftward	-50 - 50
	Adjusts picture position vertically.	VOL ▶ :upward VOL ◀ :downward	-50 - 50
Degauss	Degauss the set.	Use VOL ◀/▶ to confirm	
H-Phase	Adjusts signal's horizontal centre.	VOL ▶ :rightward VOL ◀ :leftward	-10 - 10

Operation in HDTV mode

2. XGA Mode

Buttons' function

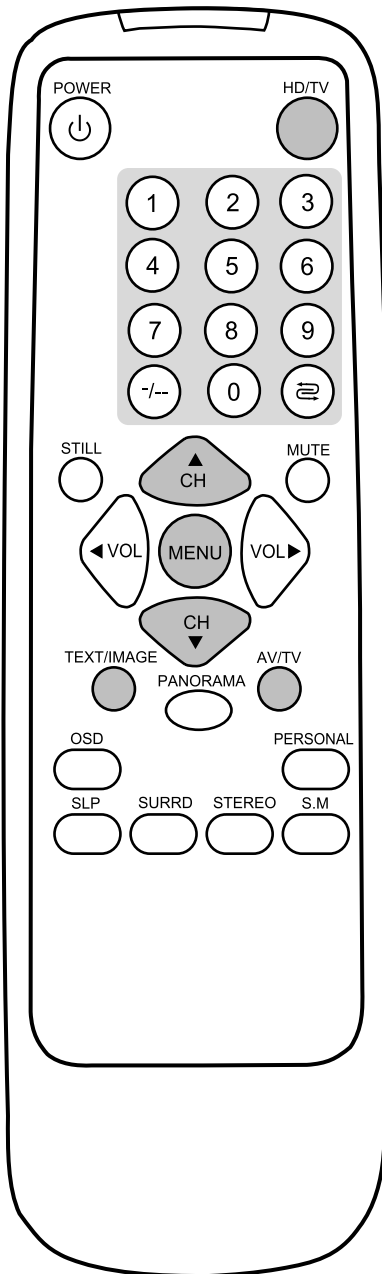

When the signal source is input through XGA interface, then the set will work in HDTV mode.

The XGA IN interface on this set can be used to connect to the following equipment:

1. PDVD with VGA output.
2. HDTV set top box with VGA output.
3. Personal computer.

Firstly please press **AV/TV** button to call up the signal source selection menu and then select **XGA** mode.

Later on you can directly press **HD/TV** button to switch between the previous viewing mode (RF or VIDEO mode) and HDTV mode.

- If you select XGA as input signal source while there is no input signal through XGA interface, the screen will display "**NO SIGNAL**". At this time, pressing **MENU** button has no function.

NO SIGNAL

- If XGA input signal is in 1080i/50Hz format, then for menu operation please refer to **Operation in YPbPr mode** in previous page.
- If XGA input signal is in other format, for its operation please see the following instructions (from page 29 to page 33).

Moreover, there is only one group of audio input terminals in HDTV mode, therefore you can only select to connect either XGA or YPbPr audio terminals.

Buttons' function

MENU on the set or **MENU** on the remote controller: It is used to call up OSD menu, or to enter or exit from the selected menu item after OSD menu is activated.

CH+ on the set or **CH▲** on the remote controller: It is used to move the cursor upward or clockwise after OSD menu is activated, or increase the value of parameter after menu item is selected.

CH- on the set or **CH▼** on the remote controller: It is used to move the cursor downward or anti-clockwise after OSD menu is activated, or decrease the value of parameter after menu item is selected.

TEXT/IMAGE: It is used to cancel the OSD menu after OSD menu is activated. It is also used to switch between text mode and image mode (in either mode contrast and brightness are different).

OSD menu introduction

OSD menu overview

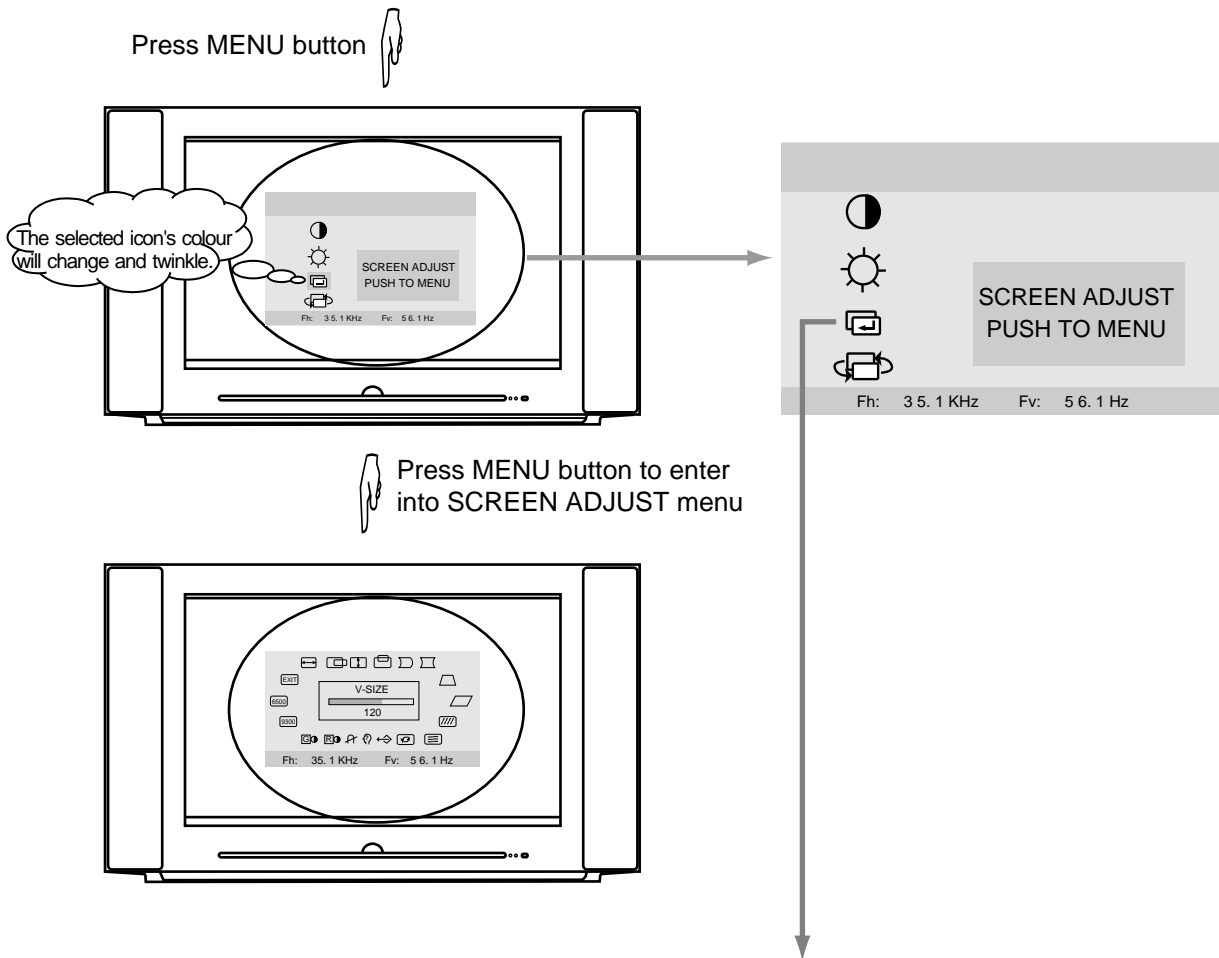

H-PHASE V-PHASE PIN-CUSHION

H-SIZE V-SIZE PIN-BALANCE TRAPEZOID

EXIT
EXIT

6500
6500K

9300
9300K

***** (SELECTED ITEM NAME)
[Progress Bar]
(ADJUSTMENT ITEM'S RANGE/POSITION)

PARALLELOGRAM

H-MOIRE

V-MOIRE

ENGLISH → 中文



DEGAUSS RECALL ROTATION

OSD menu introduction & Operation examples

OSD menu introduction (continued)

CONTRAST		Adjust the picture contrast.
BRIGHTNESS		Adjust the picture brightness.
H-SIZE		Adjust the picture's horizontal size.
H-PHASE		Adjust the horizontal position of the picture.
V-SIZE		Adjust the picture's vertical size.
V-PHASE		Adjust the vertical position of the picture.
PIN-BALANCE		Balance pincushion distortion.
PINCUSHION		Pincushion correction.
TRAPEZOID		Correct the trapezoid distortion.
PARALLELOGRAM		Adjust the angle between horizontal and vertical.
H-MOIRE		Eliminate horizontal moire.
V-MOIR		Eliminate vertical moire.
ROTATION		Rotate the current picture.
RECALL		To restore to original factory preset mode.
ENGLISH/CHINESE		English/Chinese menu on-screen display language selection.
DEGAUSS		Manually degauss the set
R		Adjust white balance R at current colour temperature (red adjustment).
G		Adjust white balance G at current colour temperature (green adjustment).
9300K		Restore the current picture's colour temperature to 9300K.
6500K		Restore the current picture's colour temperature to 6500K.
EXIT		Exit the current OSD and store all the current adjusted parameters.

Notes:



When the HD monitor gets signal from external equipment (such as Set top box, computer, DVD, etc.) through XGA interface, because of signal difference, the screen colour may not be in optimum state, this time, you can adjust  and  item in the SCREEN ADJUST menu until you get satisfying colour.

Using  or  can restore the value of  and  to default setting.

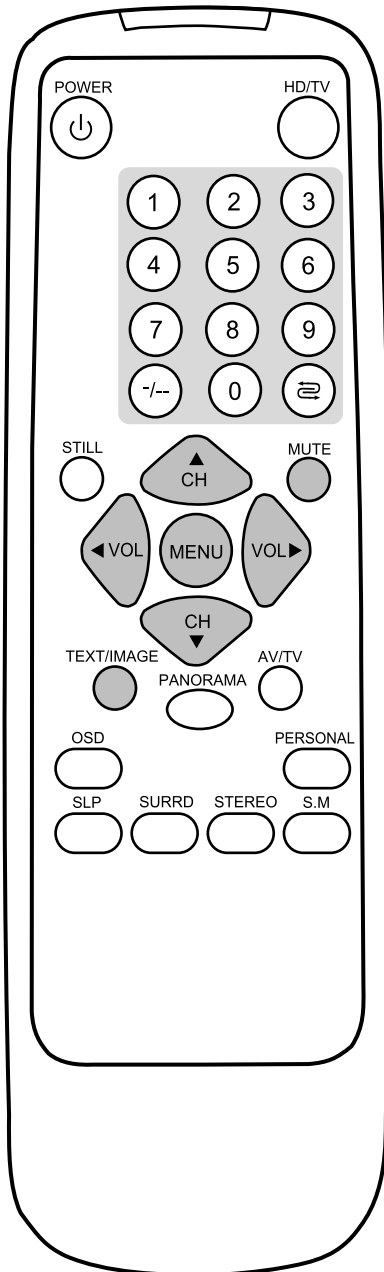
Operation examples



Contrast/brightness adjustment

- 1 Press **MENU** button to call up the OSD main menu.
- 2 Press **CH▲** button or **CH▼** button to move the cursor upward or downward and select  (Contrast) or  (Brightness) (The colour of the selected icon will change and glitter).
- 3 Press **MENU** to enter into the sub-menu.
- 4 Press **CH▲** or **CH▼** to adjust the level.
- 5 Press **MENU** to exit from the adjustment of current item.

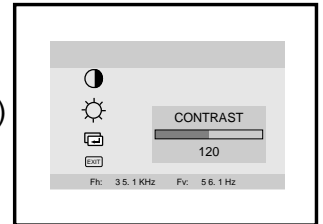

Repeat the above 2~5 steps if you want to continue the adjustment. After completion of the adjustment, press **TEXT/IMAGE** button to exit the main menu, or you can wait for some time and the menu will automatically disappear.

To switch between text mode and image mode

- 1 Press **TEXT/IMAGE** button can switch between **Text** mode and **Image** mode. In either mode, the contrast and brightness are different.
- 2 Press **MENU** button to exit. Or you can wait for some time and the OSD will automatically disappear.
If you are not satisfied with current status' contrast and brightness, you can adjust them in the main menu.

Sound adjustment

The sound adjustment is same to **Operation in RF mode**. The audio parameters you have set in RF mode such as Bass, Treble and Loudness also function in XGA mode.

Operations examples (continued)

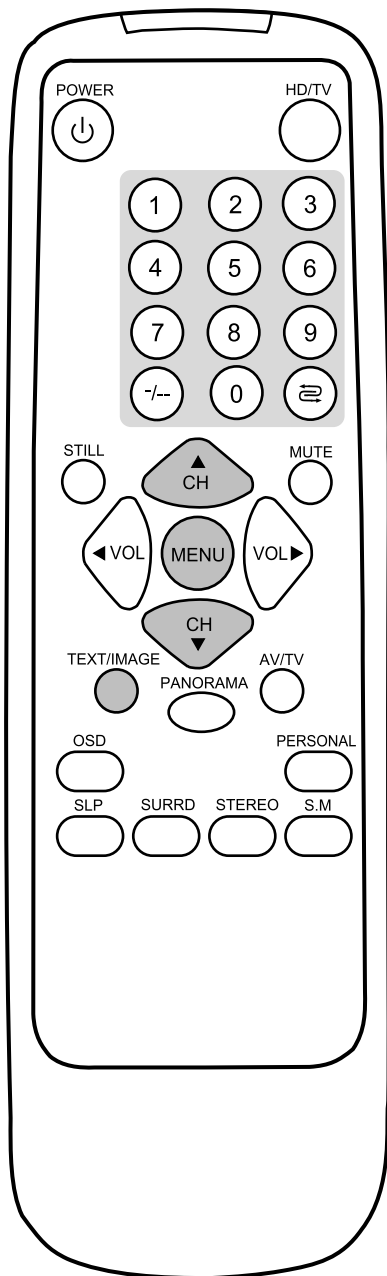

Screen adjustment

The screen adjustment includes H-SIZE, H-PHASE, V-SIZE, VPHASE, PIN-BALANCE, PINCUSHION, TRAPEZOID, PARALLELOGRAM, H-MOIRE, V-MOIRE, ROTATION, etc.

- 1 Press **MENU** button to call up the main menu, press **CH▲** or **CH▼** button to move the cursor to **SCREEN ADJUST** icon.
- 2 Press **MENU** button again to enter into **SCREEN ADJUST** sub-menu.
- 3 Press **CH▲** or **CH▼** button to move the cursor and select your wanted menu item.
- 4 Press **MENU** button to confirm the choice. If the value of the item is adjustable, go to the next step, otherwise go to above 3 step after completion of switch operation if you want to continue the adjustment.
- 5 Press **CH▲** or **CH▼** button to adjust the level until you are satisfied.
- 6 Press **MENU** button to exit this item's adjustment.
- 7 Repeat the above 3~6 steps to adjust other items. After completion of adjustment, select **EXIT** icon or press **TEXT/IMAGE** button to exit the **SCREEN ADJUST** menu. Or you can wait for some time and the OSD will automatically disappear.

Function menu item's selection

RECALL: It's used to restore parameters of the current display mode to factory default setting.

EXIT: It's used to exit the current OSD menu.

DEGAUSS: It's used to activate the degaussing circuit. (To conduct the next degauss operation you should wait for 10-20 minutes.

6500: It's used to set the state of colour temperature which suits for professional departments such as television and broadcast station.

9300: It's used to set the state of colour temperature which suits for general user.

Display mode setting

In factory the set has been set with multi display modes which are frequently-used at present. With the development of digital processing technology, in the future there are external equipment with different display modes. If user discovers the input signal's display mode is different, while the horizontal and vertical frequency accords with the requirement of the set, the set can also support this display mode. User is only required to adjust this mode's display parameters to satisfying status according to **Operation in HDTV mode** and the adjusted parameters will be stored into the MEMORY automatically even if you turn off the set.

MODE	ITEM	INPUT SIGNAL		OUTPUT SIGNAL		ADOPTIVE STANDARD	ASPECT RATIO
		Format	H-frequency/ V-frequency	Format	H-frequency/ V-frequency		
TV/AV/YCbCr	1	720x586i	15.625kHz/50Hz	1440x576P	46kHz/75Hz	PAL interlace	4:3
	2	720x480i	15.625kHz/60Hz	1440x480P	47kHz/90Hz	NTSC interlace	4:3
XGA	3	1920x1080i	28.125kHz/50Hz	1920x1080i	40.3kHz/72Hz	China HDTV interlace	16:9
	4	1920x1080i	33.75kHz/60Hz	1920x1080i	33.75kHz/60Hz	America HDTV standard interlace	16:9
	5	1280x720P	45kHz/60Hz	1280x720P	45kHz/60Hz	America HDTV standard progressive	16:9
	6	640x480P	31.5kHz/60Hz	640x480P	31.5kHz/60Hz	PC VGA	4:3
	7	640x480P	37.8kHz/75Hz	640x480P	37.8kHz/75Hz	PC VGA	4:3
	8	720x400P	31.5kHz/70Hz	720x400P	31.5kHz/70Hz	PC VGA	4:3
	9	800x600P	37.88kHz/60Hz	800x600P	37.88kHz/60Hz	PC SVGA	4:3
	10	800x600P	46.8kHz/75Hz	800x600P	46.8kHz/75Hz	PC SVGA	4:3
	11	1024x768P	48.4kHz/60Hz	1024x768P	48.4kHz/60Hz	PC XGA	4:3
YPbPr	12	640x480P	31.5kHz/60Hz	640x480P	31.5kHz/60Hz	PDVD NTSC	4:3/16:9
	13	720x576P	31.5kHz/50Hz	1440x576P	46.8kHz/75Hz	PDVD PAL	4:3/16:9
	14	1280x720P	45kHz/60Hz	1280x720P	45kHz/60Hz	America HDTV standard progressive	16:9
	15	1920x1080i	28.125kHz/50Hz	1920x1081i	40.3kHz/72Hz	China HDTV interlace	16:9
	16	1920x1080i	33.75kHz/60Hz	1920x1080i	33.75kHz/60Hz	America HDTV standard interlace	16:9
	17	1280x720P	38kHz/50Hz	1280x720P	45kHz/60Hz	Australia HDTV standard	16:9

Troubleshooting Guide

Before calling service personnel, please check the following chart for a possible cause to the trouble you are experiencing.

Symptoms	Check the following items
The screen has no content, the power indicator is not lit up.	Be sure the power cord is plugged in.
The screen has no content, the power indicator is red.	The set is in standby mode. Press the power button on the remote controller to turn on the set.
Poor colour, poor tint	Contrast, colour, tint are not correctly adjusted.
Stripes appear on the screen	Possible interference of electronic interference from another TV set, a computer, an electronics game machine, a broadcast station, etc.
Spots appear on the screen	Possible interferences of automobiles, motorcycle, trolley bus, neon lamps, etc.
Double images or "ghosts"	This may be caused by reflections from nearby mountains or buildings. Check the antenna direction.
Snowy picture	It is possible that the aerial "lead-in" is damaged or comes off. Check the antenna direction.
The remote controller does not work	The batteries may be worn out. The batteries may be installed with their polarity reversed.
TV cabinet creaks	Even if the picture or sound is normal, changes in the room temperature sometimes make the TV cabinet expand or contract, making a noise. This does not indicate a malfunction.
Magnetisation phenomenon, colour spots in the screen.	Using the remote controller to turn off the set or moving the set around may result in magnetisation phenomenon. When magnetisation appears, please enter into the OPTION menu and select DEGAUSS item to degauss the set (recommended). Or by switching off the set and waiting for 10 minutes before switching on again can eliminate it.

Specifications

Monitor

Display field	Min. 659 x 370 (mm) (76WSHDA) Min. 743.8 x 419.5 (mm) (86WSHDA)
RGB bandwidth	30MHz
Video adaptor card	VGA, S-VGA, VESA VGA, XGA
XGA cable	15-pin D-Sub type (Standard VGA cable)

TV

TV system	PAL/SECAM/NTSC
Search	Auto search / Manual search
Picture	5D picture improver
RF IN	One
S-video/Video/Audio input	Three groups
DVD IN	One group
AV OUT	One group
Additional functions	ON/OFF timer, AUTO-POWER-OFF, No-signal blue screen display, etc.

The whole unit

Power supply	AC 240V, 50Hz
Power consumption	230 W
CRT	76 cm (76WSHDA) 86 cm (86WSHDA)
Sound output	8W x 2
External control mode	I ² C bus control
Surround sound	Yes
Full function remote control	Yes
Dimensions (mm)	968 (W) x 564 (H) x 570 (D) (76WSHDA) 1060 (W) x 660 (H) x 620 (D) (86WSHDA)
Weight	66 kg (76WSHDA), 85kg (86WSHDA)
Stored Temperature	-10°C ~ 50°C
Working Temperature	0°C ~ 40°C
Accessories	XGA D15 signal cable x1, RF cable x1 , Power cord x1, Remote controller x1, Owner's manual x1.

Note: Design and specifications are subject to change without notice.

PALSONIC CORPORATION PTY LTD
1 JOYNTON AVENUE
WATERLOO NSW 2017 AUSTRALIA
TEL: (02) 9313 7111
FAX: (02) 9313 7555
www.palsonic.com.au

**PALSONIC CUSTOMER SERVICE
TELEPHONE
AUSTRALIA: 1300 657 888**