

Palsonic

DVD PLAYER

MODEL: DVD7500

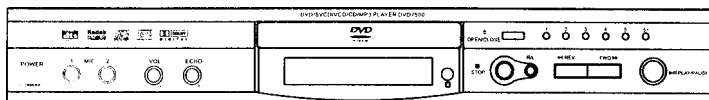

Contents

DVD Player Features	1	On-Screen Messages	26
Safety	2	Playback Displays	26
Warning	2	System Setup	27
Important Notice	2	Menu Operation	27
Player Overview	3	General Setup Menu	28
Front Panel	3	Speaker Setup	29
Rear Panel	3	Preferences Setup	30
Remote Control	4	Troubleshooting	31
Front Panel Display	5	Specifications	32
Getting Started	6	Additional Information	33
Accessories	6	Disc Care	33
Remote Control Operation	6	Disc Cleaning	33
System Connections	7	Disc Storage	33
Initial Setup	9		
Supported Disc Formats	9		
Playback Features	10		
Basic Playback	10		
Playing Desired Title / Chapter / Time	12		
DVD PBC Playback	14		
Special Playback Features	15		
Playing VCDs	21		
Playing Audio CDs	23		
Playing MP3 Files	24		
Viewing Picture CDs	25		





Features

Thank you for choosing the Palsonic DVD Player. We strongly recommend that you carefully study this user's guide before attempting to operate the unit and keep it for reference.

Your player provides:

- Composite video, S-video and component video (Y, Cb, Cr) outputs.
- Coaxial and optical audio outputs with Dolby Digital and DTS bitstream.
- Stereo audio output.
- Hi-end sound quality: 96KHz/24bit audio digital processor.
- Intelligent software upgradability.
- Compatible with DVD-Video, Video CD (VCD) Audio CD (CD-DA), HDCD, Picture CD and MP3 on CD-R/CD-RW.

TO REDUCE THE RISK OF FIRES AND ELECTRIC SHOCK, DO NOT EXPOSE THIS UNIT TO RAIN OR MOISTURE!

	<p>CAUTION: To reduce the risk of fire and electric shock do not remove the cover of the unit. Refer servicing only to qualified personnel.</p>
	<p>This lightning flash arrow symbol in a triangle is intended to alert users to the presence of non-insulated high voltage within the product's enclosure that may be of sufficient magnitude to constitute a risk of electric shock to a person.</p>
	<p>The exclamation point symbol in a triangle is intended to alert users to the presence of important operating and maintenance instructions in the literature accompanying the unit.</p>
	<p>CAUTION: INVISIBLE LASER RADIATION WHEN OPEN AND INTERLOCK DEFEATED. AVOID EXPOSURE TO BEAM. Use of controls adjustments or performance of procedures other than those specified herein may result in hazardous radiation.</p>

IMPORTANT NOTICE

REFER SERVICING ONLY TO QUALIFIED SERVICE PERSONNEL

- Read through this instruction manual before installation and use.
- Do not touch the power plug with wet hands.
- When disconnecting the power cord from the power outlet, hold the plug, do not pull the wire.
- Switch off the main power when the unit is not in use. (Disconnect the power plug from the power outlet when you do not intend to use the unit for a prolonged period of time.)
- Before moving the unit, remove the disc from the unit's tray first.
- Do not open the cover or touch any of the components inside the unit.
- Do not install or operate the unit directly exposed to sunlight or nearby objects radiating heat that may lead to overheating and danger to the unit.
- Do not install or operate the unit near moisture or humidity that may affect the laser head.
- Install the unit on flat surface with good air circulation. Do not cover the ventilation holes on the unit in any manner. The unit could possibly overheat and malfunction.
- Wipe the panel and case with soft dry cloth only. Do not apply any kind of thinner, alcohol or sprays when cleaning the unit.

Player Overview

VFD Display

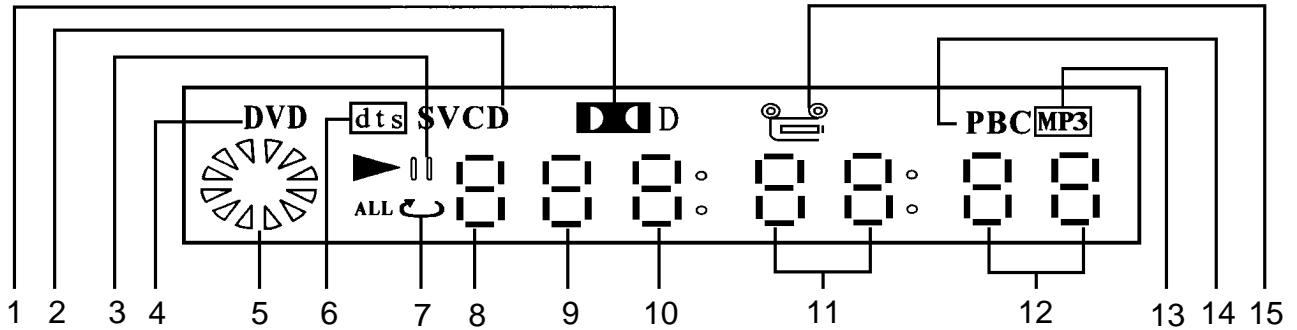

1. Dolby Digital indication
2. VCD indication
3. Pause indication
4. DVD disc indication
5. Disc running indication
6. DTS indication
7. Repeat play indication
8. Title indication
9. Chapter indication
10. Time hour indication
11. Time minute indication
12. Time second indication
13. MP3 indication
14. PBC indication
15. Angle indication

Player Overview

Remote Control

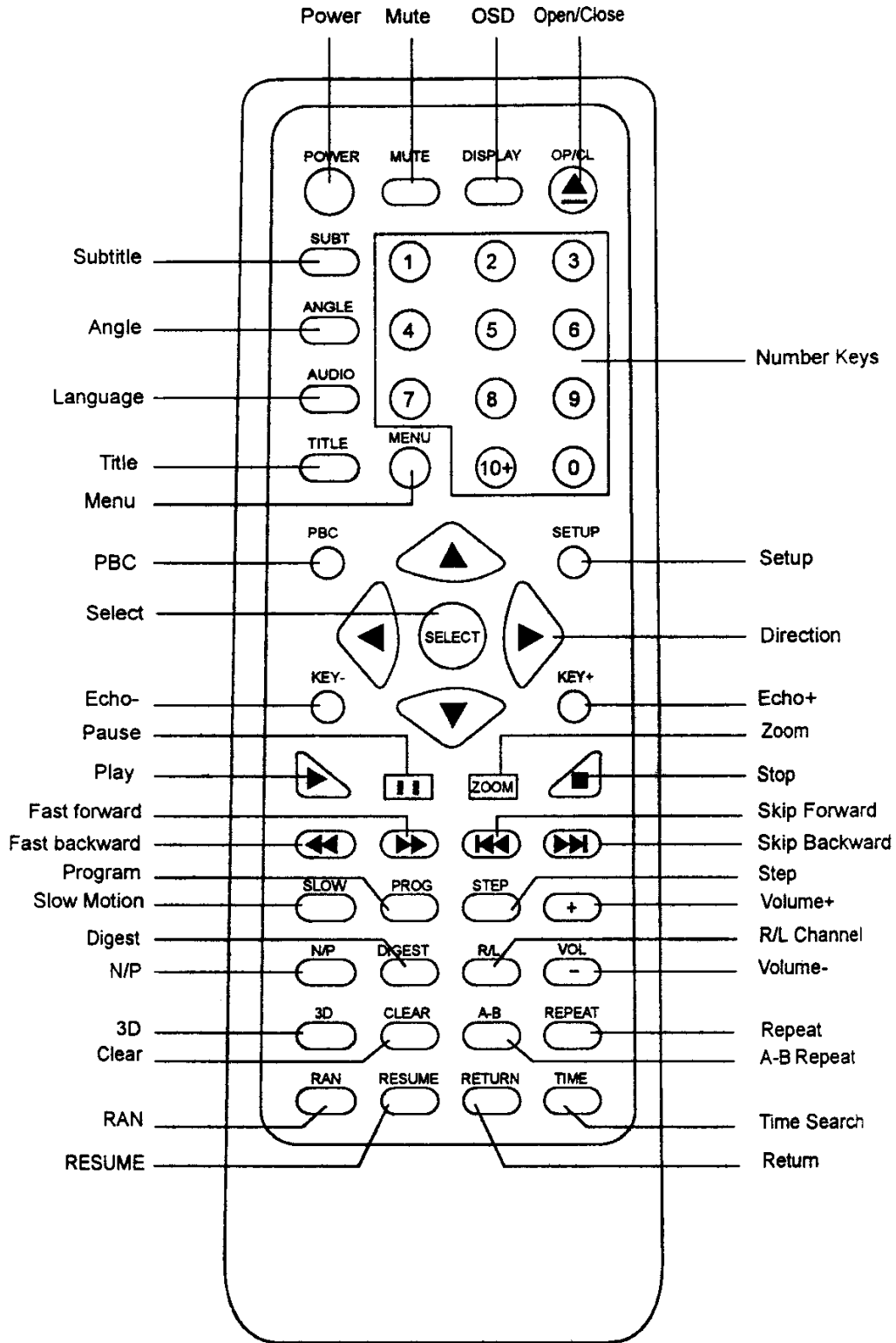

Player Overview

Front Panel

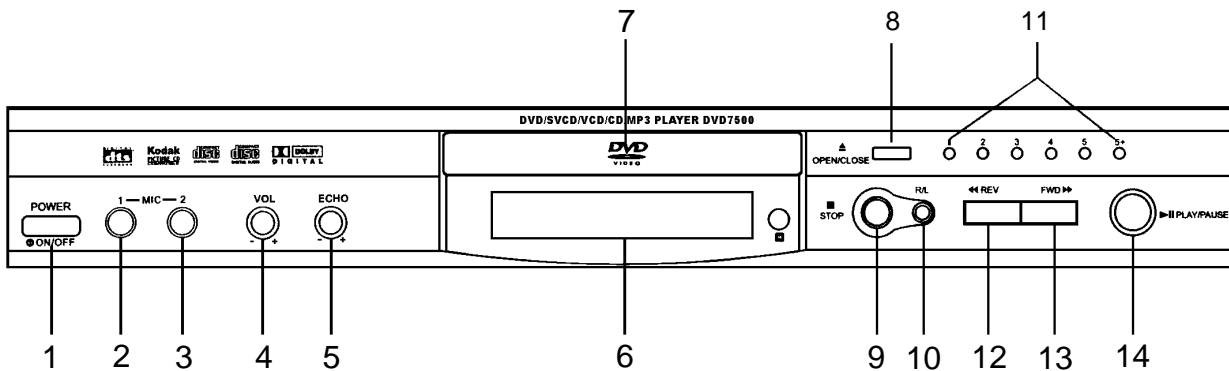

- | | |
|-----------------------|--------------------------|
| 1. Power button | 8. Open/Close button |
| 2. Mic 1 Jack | 9. Stop button |
| 3. Mic 2 Jack | 10. R/L button |
| 4. Mic volume knob | 11. Number button |
| 5. Mic echo knob | 12. Fast backward button |
| 6. VFD display window | 13. Fast forward button |
| 7. DVD disc tray | 14. Play/Pause button |

Rear Panel

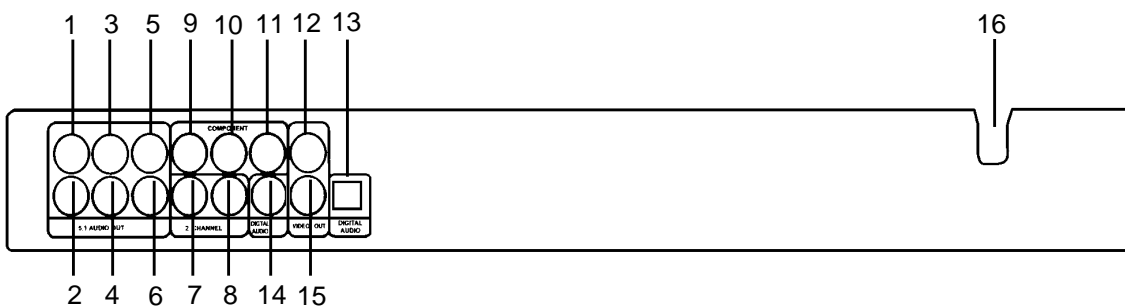

- | | |
|--------------------------------|----------------------------|
| 1. Left front vocal output | 9. Chromatism Y output |
| 2. Left surround vocal output | 10. Chromatism Cb output |
| 3. Right front vocal output | 11. Chromatism Cr output |
| 4. Right surround vocal output | 12. VIDEO output |
| 5. Subwoofer output | 13. Digital optical output |
| 6. Central output | 14. Digital coaxial output |
| 7. Left AUDIO output | 15. S-VIDEO output |
| 8. Right AUDIO output | 16. Power socket |

Getting Started

Accessories

Remote Control1

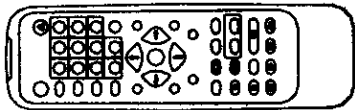

Instruction Manual 1

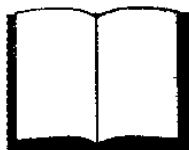

Audio cable1

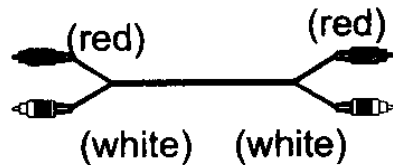

Video cable1

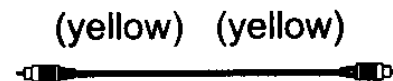

Remote Control Operation

1

Remove Battery Cover

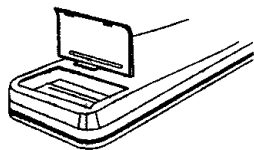

2

Insert Batteries

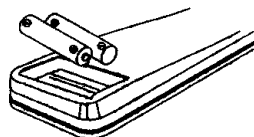

3

Close the battery cover

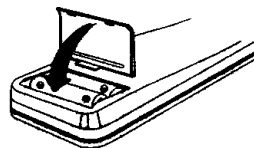

Care of remote control:

- Aim remote control toward remote sensor of unit.
- Store remote in a cool, dry place.
- Do not drop the unit.
- Do not sprinkle water or other liquid on remote control.
- Do not unpack remote control.

4

Point remote control directly toward the remote sensor.

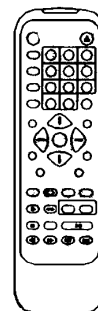
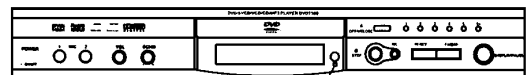

Note:

- Please operate remote control within the distance of 25 feet away from the unit.
- Do not expose remote control sensor directly to the heat source, or it will cause remote control to malfunction.

Getting Started

System Connection

Video Connection

- The unit supports two choices of video output: composite video and S-video scart and Component video output. Scart output obtains the best picture quality, followed by Component video output.

Composite Video Output

- Connect the supplied video cable (yellow) to the video output (yellow) of the unit and to the video input of your TV or monitor.

S-Video Output

- Connect an S-video cable (not included) to the S-video output of the unit and to the S-video input of your TV or monitor.

Component Video Output

- Connect an Component video cable (not included) to the Component video output of the unit and to the Component video input of your TV or monitor.

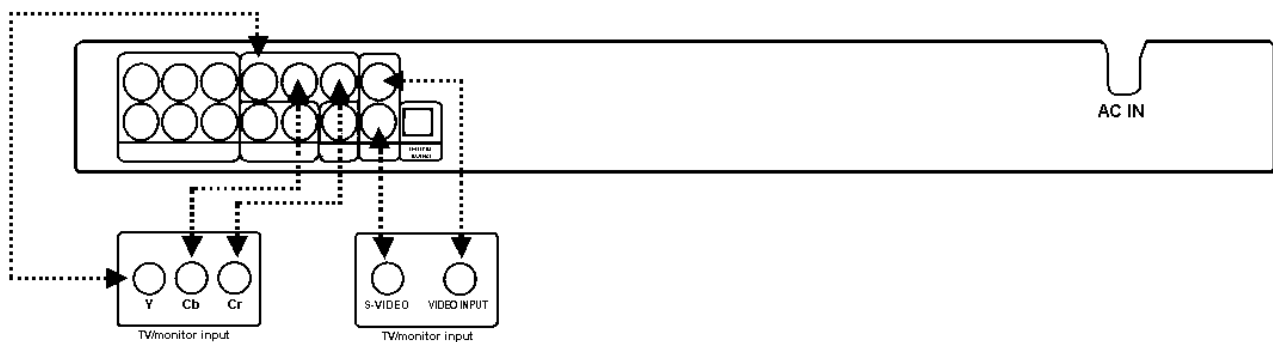

Note:

- Select the type of connection depending on the TV/monitor input.
- Only one video connection type is needed.

Getting Started

System Connection

Audio Connection

- The unit supports two choices of audio output: Analogue Audio and Digital Audio. Analogue Audio includes stereo 2 channel and Digital Audio provides optical and coaxial outputs. Digital Audio includes optical and coaxial output, Digital Audio obtains a greater effect than analogue.

Stereo Output

- Connect a couple of RCA (right, white left) to the mixing audio of the unit and to the stereo input of the TV or amplifier.

Coaxial Output

- Connect the special coaxial cable to the coaxial output of the unit and to the corresponding input of your decoder/amplifier (with digital coaxial input).

Optical output

- Connect special optical cable to the optical output of the unit and to the corresponding input of your decoder/amplifier (with digital optical input).

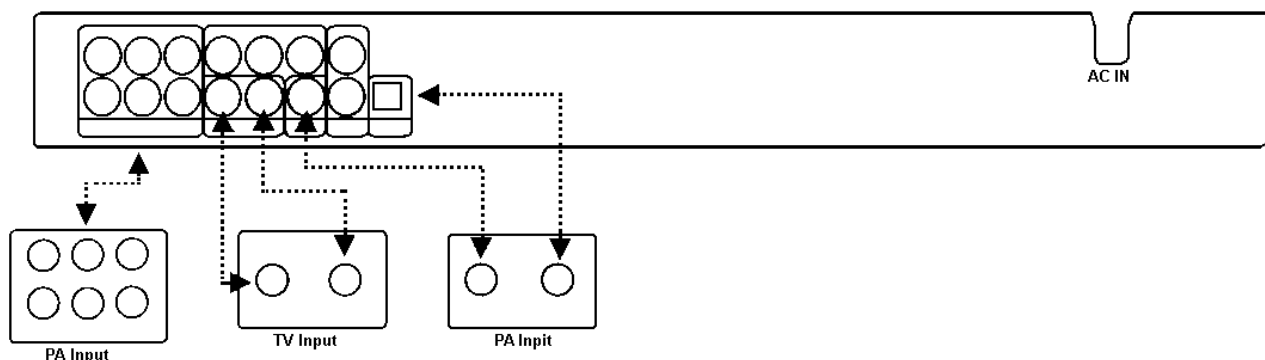

Note:

- Select the type of connection depending on your equipment, if only TV available, only stereo output can be used.
- If 5.1 ch amplifier is available you can appreciate AC-3 home theatre effects.
- If an amplifier with coaxial or optical inputs is available, you can appreciate DTS and MPEG-II digital sound effects.
- Each connection must match to the internal setup of the unit, please refer to the instruction of karaoke and system setup.

Getting Started

Setup Before Operation







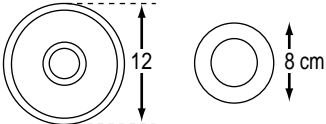

Before operation, please make sure the following setup is correct.

1	Audio Output	The unit has three choices of audio outputs: 2 channel (Lt/Rt) Stereo PCM, Digital. Select different setup depending on your connection. For more information, please refer to "System Setup" (page 30).
2	TV System	Select the corresponding system depending on your TV system. For more information, please refer to "System Setup".
3	Video Output	The unit has three choices of video outputs: Composite video, S-video, and Component video output. Select different setup depending on your connection. For more information, please refer to System Setup.

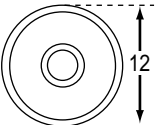
Note:

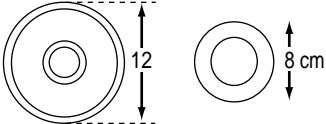

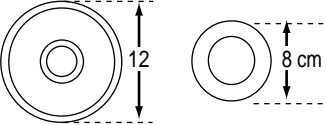
- DVD disc can support different scale of pictures. maybe picture is not full screen or part of picture has been blocked.
- The manual refers to English OSD.

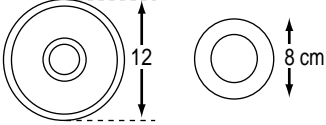
Types of Discs That Can Be Used

Disc	Size	Symbol	Content
DVD			audio + video
MP3			audio
Video CD (VCD)			audio + video
Audio CD (CD-DA)			audio
Kodak picture CD			video

Playback Features

Basic Playback



A Getting Started	
1 Power 	Power on the unit. Press POWER button on front panel. Power indicator will light.
2 Open/Close 	Press OPEN/CLOSE to open the tray.
3	Place disc on the tray with label side up.
4 Open/Close 	Press Open/Close again, the tray will close and begin to play disc.

Note:

- Do not move the unit during operation, or the disc may be damaged.
- Do not touch the tray while it is moving, or the unit may malfunction.
- Do not press the tray or place foreign objects on the tray, or the unit may malfunction.

Playback Features







Basic Playback

A Changing Discs	
Open/Close 	<p>Press OPEN/CLOSE. Replace the disc after the tray is fully open.</p> <p>Note:</p> <ul style="list-style-type: none">• Press the button again after replacing the disc.• Do not press the button while the unit is loading the disc.
C Stop	
Stop 	<p>Press STOP once to memorise the stopped position. When you press PLAY, the disc will resume play from the stopped position.</p> <p>Press STOP twice to stop and reset the disc. When you press PLAY, the disc will play from the beginning.</p>

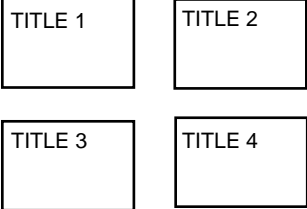
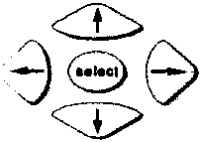
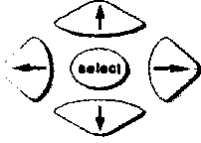
Playback Features

Playing the desired title, chapter and time

Usually, DVD discs are divided into titles and titles are divided into chapters.



A Title Menu	If the disc contains multiple titles, it may have a Title menu to access them.
1 TITLE 	Press TITLE to display the title menu. 
2 	Use the arrow keys to select the desired title. You can use the 0-9 keys to select the title if numbers are indicated in the Title menu.
3 	Press SELECT to start playback from the first chapter of the selected title.
B Skip Playback	
Skip backward  Skip forward 	Press  or  . Press  to skip to the previous chapter. Press  to skip to the next chapter.

Note:

- Some discs do not display the title contents after pressing TITLE.
- The operation may vary according to the DVD disc.

Playback Features

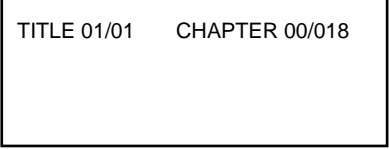
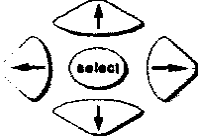
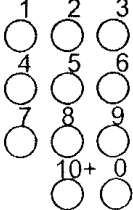
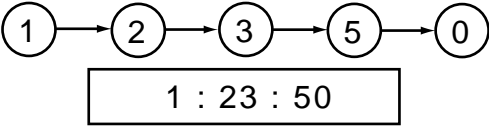
Playing the desired title, chapter and time

<p>C</p>	<p>You can choose your desired title, chapter and time.</p>	
<p>1</p> <p>TIME</p> 	<p>Press TIME button, displaying: For example:</p>	
<p>2</p> 	<p>Press the Arrow Keys to select Time Search , Chapter Search or Title Search.</p>	
<p>3</p> 	<p>Press the 0-9 keys to enter the time (hours, minutes and seconds) or the number of the title or chapter.</p> <p>For example: Time</p>	
<p>4</p> <p>Select</p> 	<p>Press SELECT to start playback from the selected time, chapter or title.</p>	

Note:

- Pressing the numbers beyond selection will cause invalidity.



Playback Features

DVD PBC Playback

A	You can use an alternate means of disc navigation for DVDs.																					
Close navigational system	<p>Press PBC button and the screen will display a summary of the disc contents:</p> <div data-bbox="746 577 1310 1064" data-label="Image"><table border="1"><thead><tr><th>DISC</th><th>TTL1</th><th>TTL2</th></tr></thead><tbody><tr><td>TOTAL TITLES</td><td></td><td>01</td></tr><tr><td>PLAY TIME</td><td></td><td>17</td></tr><tr><td>PLAY ENTRIES</td><td></td><td>01:07:40</td></tr><tr><td>AUDIO STREAMS</td><td></td><td>02</td></tr><tr><td>SUBPIC STREAMS</td><td></td><td>02</td></tr><tr><td colspan="3">MPG2 NTSC 4:3 AC3-5.1 AC3-5.1</td></tr></tbody></table></div> <p>Press the left/right buttons to select different titles. The relevant information for the selected title will be displayed. Press the SELECT key to play the selected title. You can also press the 0-9 keys to start playback of the desired title.</p>	DISC	TTL1	TTL2	TOTAL TITLES		01	PLAY TIME		17	PLAY ENTRIES		01:07:40	AUDIO STREAMS		02	SUBPIC STREAMS		02	MPG2 NTSC 4:3 AC3-5.1 AC3-5.1		
DISC	TTL1	TTL2																				
TOTAL TITLES		01																				
PLAY TIME		17																				
PLAY ENTRIES		01:07:40																				
AUDIO STREAMS		02																				
SUBPIC STREAMS		02																				
MPG2 NTSC 4:3 AC3-5.1 AC3-5.1																						
B																						
Program playback	Press PROGRAM to select a chapter within the title Press again to clear the mode.																					
C																						
Return to navigational system	Press PBC to return to the navigational system, which is the normal mode of operation.																					

Playback Features

Special Playback Features

<h3>A Skip</h3>	
<p>Fast backward</p>  <p>Fast forward</p> 	<p>During playback, press ▶▶ fast forward or ◀◀ fast backward. Every press of ◀◀ or ▶▶ will change the speed.</p> <p>◀◀ : Fast backward</p> <pre> graph LR A[x2] --> B[x4] B --> C[x8] C --> D[x16] D --> E[play] </pre> <p>▶▶ : Fast forward</p> <pre> graph LR A[x2] --> B[x4] B --> C[x8] C --> D[x16] D --> E[play] </pre>

- Note:
- The unit will be muted when skipping forward and backward.
 - Some discs do not support skip playback.
 - Operation may vary from disc to disc.

<h3>B Step</h3>	
<p>step</p> 	<p>Pressing STEP the first time will freeze the picture.</p> <pre> graph TD A[step] --> B[step] </pre> <p>Successive presses will move the picture forward one frame.</p>

<h3>C Pause/Play</h3>	
	<p>Press Pause/Play to pause the picture.</p>

<h3>D Return to</h3>	
<p>Play</p> 	<p>Press PLAY to resume normal play.</p>

Note: The unit will be mute during step playback.

Playback Features

Special Playback Features

You can set chapters/titles to repeat.

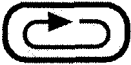
<p>E Repeat title/chapter</p>	<p>Repeat your desired title/chapter.</p>
<p>repeat</p> 	<p>Each press of the REPEAT button will change the repeat mode as follows:</p> <pre> graph TD A[CHAPTER REPEAT ON] --> B[TITLE REPEAT ON] B --> C[REPEAT OFF] C --> A </pre> <p>repeat the chapter</p> <p>repeat the title</p> <p>return to normal play</p>

Note: Some discs do not support repeat playback.

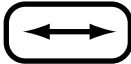
<p>F Repeat passage</p>	<p>You can repeat playback of a segment (A-B)</p>						
<p>A-B</p> 	<table border="1"> <tr> <td data-bbox="432 1370 756 1507"> <p>A TO B SET A</p> </td> <td data-bbox="791 1370 1358 1476"> <p>Press A-B button at the beginning of the desired segment, memorising the starting point A.</p> </td> </tr> <tr> <td data-bbox="432 1568 756 1704"> <p>A TO B SET B</p> </td> <td data-bbox="791 1568 1358 1673"> <p>Press A-B button at the end of the desired segment. The unit will repeat your selected segment A-B.</p> </td> </tr> <tr> <td data-bbox="432 1760 756 1897"> <p>A-B CANCELLED</p> </td> <td data-bbox="791 1760 1358 1827"> <p>Press A-B button a third time to clear the setting and return to normal.</p> </td> </tr> </table>	<p>A TO B SET A</p>	<p>Press A-B button at the beginning of the desired segment, memorising the starting point A.</p>	<p>A TO B SET B</p>	<p>Press A-B button at the end of the desired segment. The unit will repeat your selected segment A-B.</p>	<p>A-B CANCELLED</p>	<p>Press A-B button a third time to clear the setting and return to normal.</p>
<p>A TO B SET A</p>	<p>Press A-B button at the beginning of the desired segment, memorising the starting point A.</p>						
<p>A TO B SET B</p>	<p>Press A-B button at the end of the desired segment. The unit will repeat your selected segment A-B.</p>						
<p>A-B CANCELLED</p>	<p>Press A-B button a third time to clear the setting and return to normal.</p>						

Note:

- The repeated can only be selected in the current title.
- A-B Repeat can not be used for multi-angle segments.

Playback Features

Special Playback Features

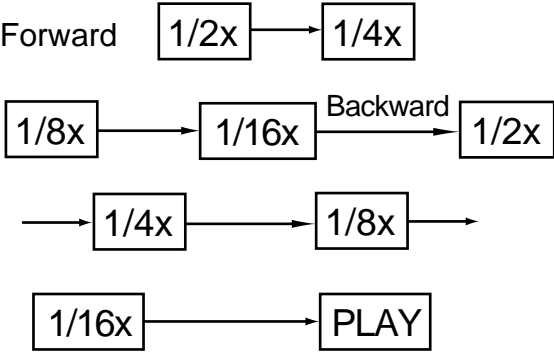
G Slow	You can play back in slow motion.
<p>slow</p> 	<p>Press SLOW button and the speed will change as follows:</p>  <pre>graph LR subgraph Forward F1[1/2x] --> F2[1/4x] end subgraph Backward B1[1/16x] --> B2[1/2x] end S1[1/8x] --> S2[1/16x] S3[1/4x] --> S4[1/8x] S5[1/16x] --> S6[PLAY]</pre>

Note:

- Audio will be mute during slow motion.

H Return to normal play	
	Press PLAY to resume normal playback.

Playback Features

Special Playback Features

select angle



select language

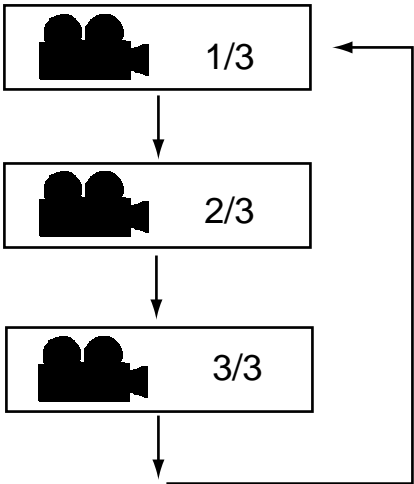

<p>Select angle</p>	<p>Use the Angle feature for discs with multi-angle scenes.</p>
<p>Angle</p> 	<p>While playing multi-angle scene, press ANGLE to select as follows:</p> <div style="text-align: center;">  </div>

Note:

- While playing a multi-angle scene, the angle will always be displayed on the screen if the angle is set to ON in the setup menu.

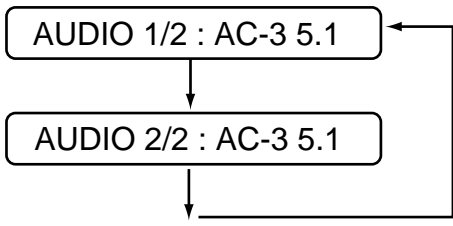
<p>Select language</p>	<p>Select your desired language from the choices which the disc contains.</p>
<p>AUDIO</p> 	<p>In play mode, press the button changing the language</p> <div style="text-align: center;">  </div> <p>Every press will change the language.</p>

Note:

- The unit will return to the default setup when you turn on the unit or when you change discs
- The unit will play the original language if you select a language the DVD disc does not contain.

Playback Features

Special Playback Features

K Mute	
mute ○	Press MUTE to turn off the audio. Press MUTE again to resume normal sound.

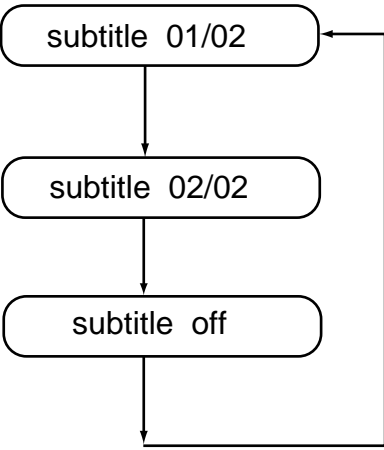



A Select subtitle	You can select subtitles from the choices which the disc contains.
SUBT ○	While playing a disc with subtitles, press the SUBT button as follows:  <pre>graph TD; A[subtitle 01/02] --> B[subtitle 02/02]; B --> C[subtitle off]; C --> A;</pre>

Note:

- The unit will return to default setup when you turn on the device or when you change the disc.
- The unit will display the original subtitle language if you select a subtitle not contained in the disc.
- The subtitle may take a few moments to change.
- Not all discs contain subtitles.

Playback Features

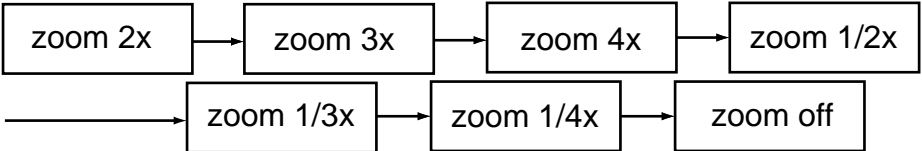
Special Playback Features

<p>M Memorise the stopped position</p>	<p>The unit can continue playing from the stopped position.</p>
<p>1 Stop</p> 	<p>Press STOP at the desired stopping position. The unit will memorise the position.</p> <p>Note: Some discs may not support this function.</p>
<p>2 Play</p> 	<p>Press PLAY to start playback from the memorised position.</p>
<p>N ZOOM</p>	<p>You can ZOOM in while watching movies.</p>
<p>1 Zoom</p> 	 <pre> graph LR A[zoom 2x] --> B[zoom 3x] B --> C[zoom 4x] C --> D[zoom 1/2x] E[] --> F[zoom 1/3x] F --> G[zoom 1/4x] G --> H[zoom off] </pre>
<p>2 arrow keys</p>	<p>In zoom mode, press the arrow keys to move in the selected direction.</p>
<p>O Switch system</p>	<p>You can switch output systems conveniently</p>
<p>N/P</p> 	<p>Press N/P key, switching between PAL and NTSC automatically.</p> <p>Note you can also set the system in the setup menu.</p>

Note:



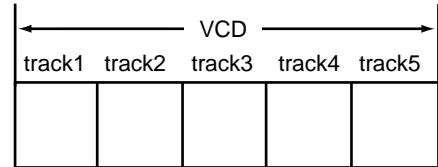

- Resume playback does not work in the following conditions: 1 Unplug power cord after turning off the unit. 2. Take out the disc. 3. Press STOP key repeatedly.
- The returning position may be different for different discs.

Playing Other Compatible Discs

Playing VCDs

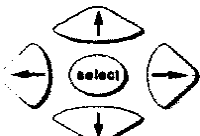
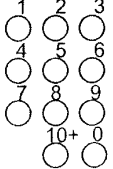



VCDs are divided into multiple tracks.

<h3>A Play from menu</h3>	<p>If the disc contains a PBC menu, you can select PBC playback. The unit will enter PBC automatically.</p>
<p>1</p> <p>PBC</p> 	<p>In stop or play mode, press PBC button displaying:</p> <div style="border: 1px solid black; padding: 5px; display: inline-block; margin-left: 200px;">PBC ON</div> <p>Note: Not all VCDs contain PBC menus. After reading the disc, the PBC menu will be displayed automatically (if the disc contains a PBC menu).</p>
<p>2</p> 	<p>Press the arrow keys to choose the desired track, then press SELECT:</p> <p>For example:</p> <div style="border: 1px solid black; padding: 5px; margin-left: 200px;"> <p>1 <input type="checkbox"/> <input type="checkbox"/> <input type="checkbox"/> <input type="checkbox"/></p> <p>2 <input type="checkbox"/> <input type="checkbox"/> <input type="checkbox"/> <input type="checkbox"/> <input type="checkbox"/></p> <p>3 <input type="checkbox"/> <input type="checkbox"/> <input type="checkbox"/> <input type="checkbox"/> <input type="checkbox"/> <input type="checkbox"/> <input type="checkbox"/></p> <p>4 <input type="checkbox"/> <input type="checkbox"/></p> <p>5 <input type="checkbox"/> <input type="checkbox"/> <input type="checkbox"/> <input type="checkbox"/></p> </div>
<p>3</p> 	<p>Alternatively, press the 0-9 keys to select the desired track. To select a number larger than 10, press 10+ first, then input the next number.</p>
<p>4</p> <p>return</p> 	<p>In play mode, press RETURN to enter the PBC menu.</p>
<p>5</p> <p>Skip forward</p>  <p>Skip backward</p> 	<p>Press ▶▶ to skip the next page.</p> <p>Press ◀◀ to skip the previous page.</p> <p>Note: Some discs may have multi-page menus.</p>

Playing Other Compatible Discs

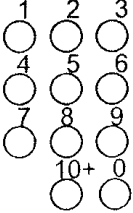
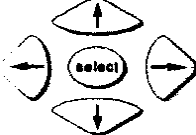
Playing VCDs

B Play your desired sequence																						
1 Program 	In stop or play, press PROGRAM <table border="0" style="margin-left: 20px;"> <tr> <td style="text-align: right;">PROGRAM</td> <td></td> <td style="text-align: right;">TRACK (01...10)</td> </tr> <tr> <td style="text-align: right;">1 --</td> <td></td> <td style="text-align: right;">6 --</td> </tr> <tr> <td style="text-align: right;">2 --</td> <td></td> <td style="text-align: right;">7 --</td> </tr> <tr> <td style="text-align: right;">3 --</td> <td></td> <td style="text-align: right;">8 --</td> </tr> <tr> <td style="text-align: right;">4 --</td> <td></td> <td style="text-align: right;">9 --</td> </tr> <tr> <td style="text-align: right;">5 --</td> <td></td> <td style="text-align: right;">10 --</td> </tr> <tr> <td style="text-align: right;">EXIT</td> <td></td> <td style="text-align: right;">NEXT</td> </tr> </table>	PROGRAM		TRACK (01...10)	1 --		6 --	2 --		7 --	3 --		8 --	4 --		9 --	5 --		10 --	EXIT		NEXT
PROGRAM		TRACK (01...10)																				
1 --		6 --																				
2 --		7 --																				
3 --		8 --																				
4 --		9 --																				
5 --		10 --																				
EXIT		NEXT																				
2 	Press number key, selecting your desired track. If the number is larger 10, press 10+ first, then input the next number.																					
3 	Press the arrow keys, then press / select / key to start.																					
4 	In program mode, press STOP to clear the play mode.																					

Playing Other Compatible Discs

Playing VCDs

Often different channels on VCDs contain different languages.

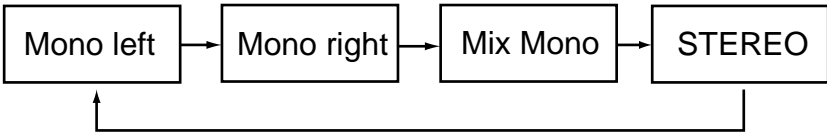
D Select channel	In play mode, press R/L key, selecting channel.
R/L 	

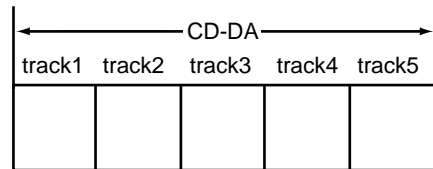

Playing Audio CDs

Audio CDs are divided into multiple tracks.

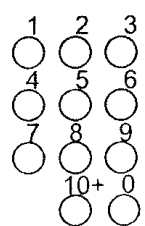
1	After reading the disc, it will play automatically.
2 	Press number key, selecting your desired track. If the number is larger than 10, press 10+ first, then input the next number.

Note:

- Press **⏮** or **⏭** to select the previous or next track.
- Press **SEARCH** to select playback time.

Playing Other Compatible Discs

Playing MP3 Files

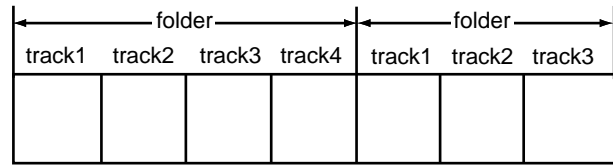

MP3 discs are divided into folders and tracks.

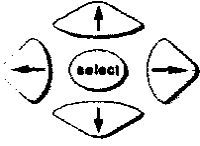
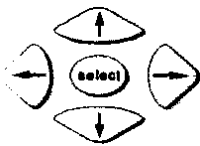

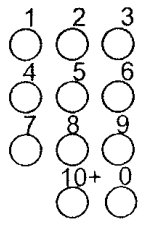
A Select track	
1	The folder menu will be displayed after reading the disc.
2 	Press the arrow keys to select the desired folder.
3 	Press SELECT to enter the item. Press the arrow keys to select desired track, then press SELECT to play the track.

B Select track directly	
	You can also press the 0-9 keys to select the desired track. If you want to select a number larger than 10, press 10+ first, then enter the second digit.

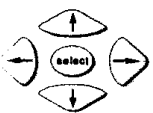
C Return to title menu	
stop 	Press STOP to return to the title menu.

D Select play mode	
	Press arrow keys to select the Playback mode In play mode Item: REP-ONE, FOLDER-REP, FOLDER.

Note:

- Press  or  to select the previous or next track.

Playing Other Compatible Discs

Playback Displays

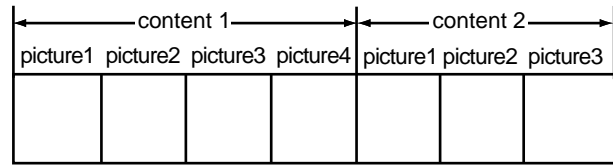

Kodak picture CDs are divided into content and pictures.

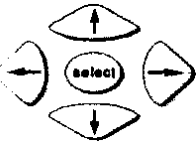
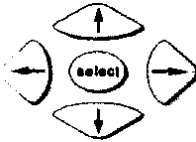
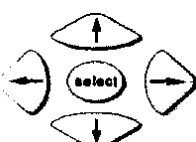





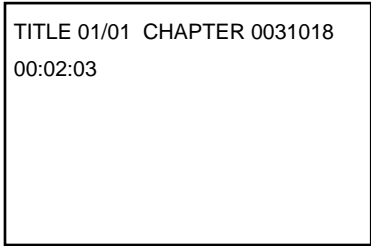

A Select content	
1	Insert the disc to display the content menu.
2 	Use the arrow keys to select the desired content, then press SELECT.
3 	Press the arrow keys to select the desired picture, then press SELECT to view the picture.
4 	Press up to play in a clockwise direction, and press down to play counterclockwise. Press left to roll left and right. Press right to roll up and down.

B Select picture directly																									
<table border="0"> <tr> <td>1</td> <td>2</td> <td>3</td> </tr> <tr> <td>○</td> <td>○</td> <td>○</td> </tr> <tr> <td>4</td> <td>5</td> <td>6</td> </tr> <tr> <td>○</td> <td>○</td> <td>○</td> </tr> <tr> <td>7</td> <td>8</td> <td>9</td> </tr> <tr> <td>○</td> <td>○</td> <td>○</td> </tr> <tr> <td></td> <td>10+</td> <td>0</td> </tr> <tr> <td></td> <td>○</td> <td>○</td> </tr> </table>	1	2	3	○	○	○	4	5	6	○	○	○	7	8	9	○	○	○		10+	0		○	○	You can also use the number keys to select the desired picture. To select a number larger than 10, first press 10+ then enter the second number.
1	2	3																							
○	○	○																							
4	5	6																							
○	○	○																							
7	8	9																							
○	○	○																							
	10+	0																							
	○	○																							

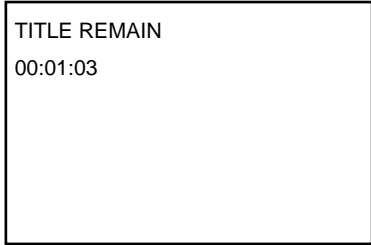
C 9-picture digest	
	Press MENU to display a 9-picture digest. Press ◀◀ or ▶▶ will turn pages repeatedly.

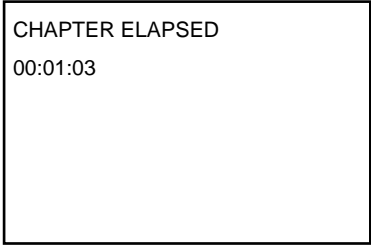
Playback Displays

You can see the number of the current chapter, title, time remaining and elapsed time of the current chapter and title.

1 DISPLAY 	Press DISPLAY once to display the elapsed time of the current title.	
2 DISPLAY 	Press DISPLAY twice to display the time remaining in the current title.	
3 DISPLAY 	Press DISPLAY three times to display the elapsed time of the current chapter.	
4 DISPLAY 	Press DISPLAY four times to display the time remaining in the current chapter.	
5 DISPLAY 	Press DISPLAY five times to turn off the time display.	

Note:

- Display information will be different if the disc is not a DVD.

System Setup

Menu Operation

- 1 Press SETUP to display the setup menu.
- 2 Press the arrow keys to move to the desired item, then press SELECT to confirm.
- 3 Press SETUP again to exit menu.
Note:
 1. The corresponding indication will appear on the bottom of screen when moving the cursor to selected item.
 2. Grey (dimmed) items cannot be set.
 3. The setup will be saved after powering off the unit.

General Setup Menu

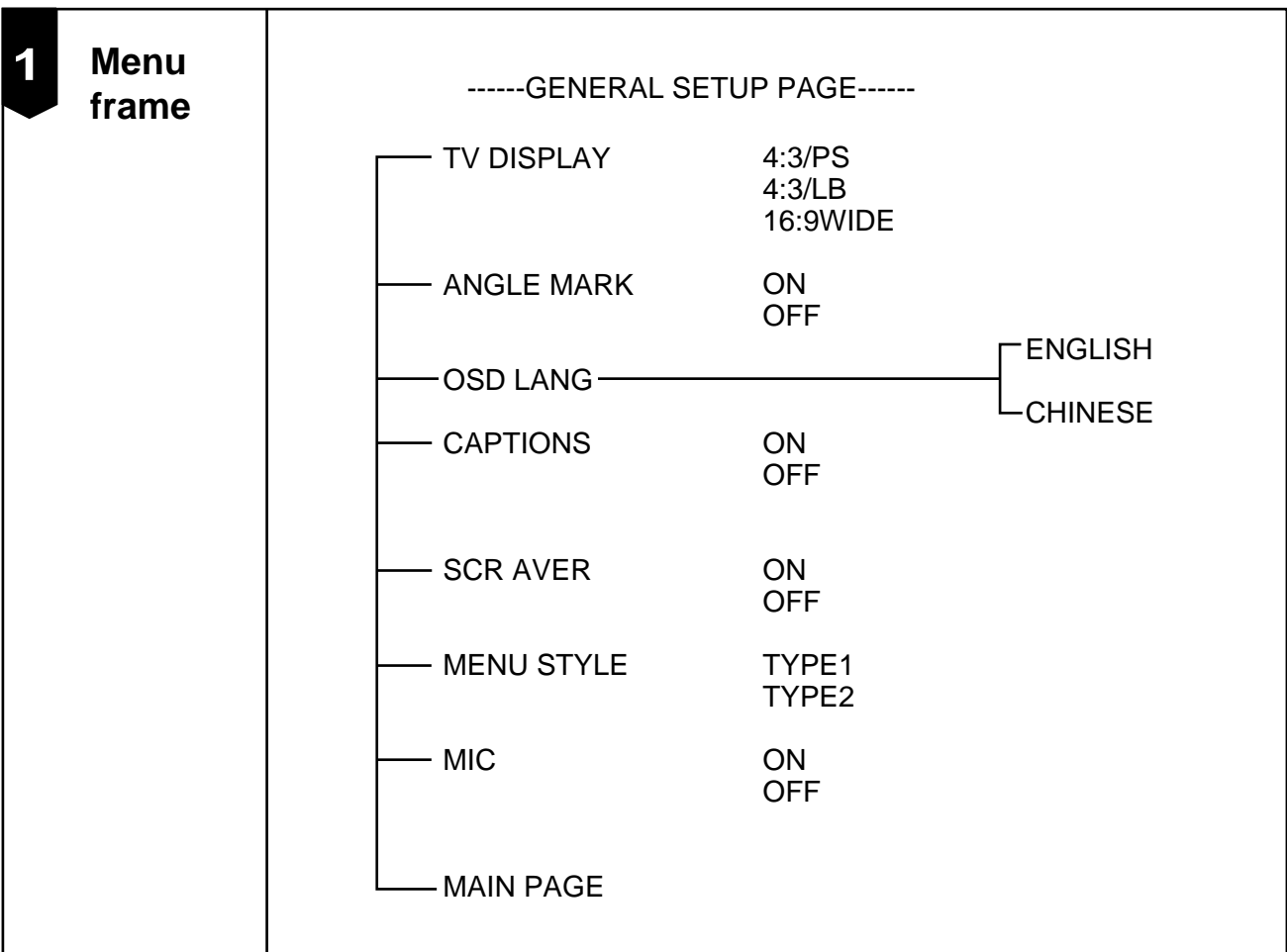

System Setup

General Setup Page

2 TV DISPLAY	<p>A. NORMAL/PS - Select to view DVD movies full screen on a standard 4:3 television. Movies will be cropped (using a technique called Pan & Scan) to fit your television.</p> <p>B. NORMAL/LB - Select to view DVD movies in letterbox format (black bars will appear above and below the image).</p> <p>C. WIDE - Select if you have a widescreen television.</p>
3 ANGLE MARK	<p>When playing multi-angle DVD discs, select whether the angle should be displayed.</p>
4 OSD LANG	<p>Select the operation language.</p>
5 CAPTIONS	<p>Set up the mode of captions.</p>
6 SCR SAVER	<p>When the unit is in stop or freeze mode, a screensaver will appear several minutes later to protect your television screen.</p>
7 MIC	<p>Set up Karaoke on or off.</p>
8 LAST MEMORY	<p>Choose memory and the player can play according to the last setup.</p>

Speaker Setup

<p>1 Menu frame</p>	<p>Speaker Setup page</p> <ul style="list-style-type: none"> DOWNMIX ————— LT/RT STEREO OFF FRONT SPEAKER ——— LARGE SMALL CENTRE ————— LARGE SMALL OFF REAR ————— LARGE SMALL SUBWOOFER ————— OFF ON TEST TONE ————— OFF ON ON DIALOG —————  POST DRC ————— ON OFF AUTO MAIN PAGE
<p>2 DOWNMIX</p>	<p>Set the type of front speaker. When playing 5.1ch, select the output signal off front speaker. LT/RT Select when using an external Dolby Pro Logic decoder. STEREO: Outputs a stereo signal. OFF: Do not Downmix to 5.1ch. NOTE: Only when Downmix is off and Karaoke is off, you can set up Centre, Rear and Subwoofer system.</p>
<p>3 SPEAKER ON/OFF</p>	<p>Set up the corresponding 5.1ch output. When subwoofer is OFF, bass will be superimposed in the left and right main channel.</p>
<p>4 TEST TONE</p>	<p>Test the connection condition: When it is set ON, if the speaker is ON, the unit will test the tone (for some time). The corresponding test information will be displayed on the bottom of TV screen. The order is: left--central--right--surround right--surround left--left. If the speaker is OFF, it will skip the test. Note: It is valid only at setup interface. When playing or exiting the setup, it will close automatically.</p>

System Setup

Preferences Setup

<p>1 Menu frame</p>	<p>Note: You can only enter Preferences setup from stop or no disc mode.</p> <p>TV TYPE PAL AUTO NTSC</p> <p>PBC ON OFF</p> <p>AUDIO SUBTITLE DISC MENU</p> <p>PARENTAL LOCATE</p> <p>DEFAULTS RESET</p> <p>ENGLISH FRENCH SPANISH CHINESE JAPANESE KOREAN RUSSIAN THAI OTHERS</p>
<p>2 TV TYPE</p>	<p>Select type according to your colourful TV mode. For mode. TV select multi. NTSC TV select NTSC and PAL TV select PAL.</p>
<p>3 PCB</p>	<p>When "PCB" is off, you can choose the songs which you like through digital knob to play CD and 2.0 disc.</p>
<p>4 Audio, Subtitle Disc Menu</p>	<p>Enter your preferred language for Audio soundtracks, Subtitle languages and Disc menu languages. Available languages vary by disc.</p>
<p>5 Parental setup</p>	<p>You can use this setup to control playback of rated discs.</p>
<p>6 LOCATE</p>	<p>The set up is valid when playing disc with regional limit.</p>
<p>7 Defaults</p>	<p>Return to the default setup.</p>

Troubleshooting

Symptoms and Solutions

If you have any questions, please refer to the following table before seeking service.

Symptom	Reason(s)	Solution(s)
No power	Not connected.	Connect unit to wall outlet.
No picture	Video cable not securely connected.	Connect video cable.
No sound	Audio cable not securely connected.	Connect audio cable.
	External amplifier/decoder off.	Power on amplifier/decoder.
	Incorrect audio output setting.	Set to correct mode.
Distorted picture	Disc is dirty.	Clean disc or try another one.
	Distortion in fast forward or backward mode.	Normal condition.
Brightness unsteady or picture with noise	External equipment.	Connect DVD player directly to TV.
No playback.	No disc.	Insert disc.
	Disc not readable.	Insert readable disc (check disc type).
	Disc loaded upside down.	Replace disc with label side up.
	Disc incorrectly loaded.	Load the disc correctly.
	Disc is dirty.	Clean the disc.
	TV screen has menu.	Press Setup to turn off the menu.
	Parental lock enabled.	Unlock it or change the rating.
Keys do not function	Abnormal condition.	Switch on/off power or unplug/replug the power cord.
Remote control does not work	Remote not pointed directly at unit. Remote too far from unit. Batteries are dead.	Point remote directly at IR sensor. Operate remote within 25 feet Replace batteries

Specifications

DVD Player/Output

DVD Player

Power Supply	110-240V AC 50/60Hz
Power Consumption	25W
Weight	3.5 Kg
Dimension	430 x 55 x 315 (W/H/D)
Video System	PAL
Laser	SL Beam, wave length: 650nm
Frequency Response	DVD audio: 48KHz PCM 4Hz~22Hz 96KHz PCM 4Hz~44KHz Audio CD 4Hz~20KHz
S/N Ratio	>90db
Audio Dynamic Range	>90db
Rotating Ratio	Within measurable range
Operation Condition	Temperature 0-40C; Operation status: horizontal

Output

Video Output	1.0 V (P-P), 75 Ω
S-video Output	(Y) 1.0 V (P-P), 75 Ω (C) 0.286 V (P-P), 75 Ω
Audio Output (Analog Audio)	2.0 V(rms)

Additional Information

Care of discs

Do not touch the surface.

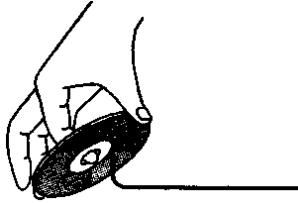

Do not add labels or adhesive tapes on discs.

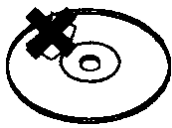

Cleaning of discs

Fingerprints or stains on the discs surface will directly affect signal recording and result in poor picture quality. Therefore, use a soft cloth and wipe in a circular manner from the centre to the outer edges when cleaning the disc.

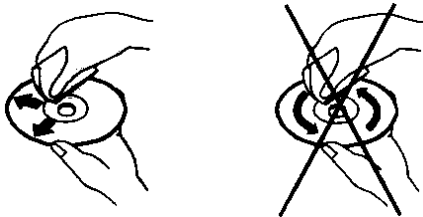

If the surface of your disc is very dirty, wipe the disc with a moist cloth. Finally use a dry soft cloth to remove all the water stains.

Never use electrostatic prevention products or solutions which contain benzene, thinner or any other vaporising substances, as they may damage the disc surface.

Storage of discs

Do not keep the disc in direct sunlight, near a heat source, in dusty places or near moisture (kitchen, bathroom). Keep the disc vertically in the disc storage case. Heavy objects on the disc case will cause deformation of the disc.

PALSONIC CORPORATION PTY LTD
1 JOYNTON AVENUE
WATERLOO NSW 2017 AUSTRALIA
TEL: (02) 9313 7111
FAX: (02) 9313 7555
www.palsonic.com.au

**PALSONIC CUSTOMER SERVICE
TELEPHONE
AUSTRALIA: 1300 657 888**