

OWNER'S MANUAL

Palsonic

**51CM CORDLESS REMOTE LCD TV/MONITOR
MODEL: TFTV-510**



Type Tested
Electrical
Safety
AS/NZ 3250
Standards Australia

**PALSONIC CORPORATION PTY LTD
1 JOYNTON AVENUE
WATERLOO NSW 2017 AUSTRALIA
TEL: (02) 9313 7111
FAX: (02) 9313 7555
www.palsonic.com.au**

**PALSONIC CUSTOMER SERVICE
TELEPHONE
AUSTRALIA: 1300 657 888**

Congratulations on your purchase of this **Palsonic LCD TV/MONITOR**.

We recommend that you thoroughly read this manual before use to fully enjoy the many functions and excellent effects of this LCD TV/MONITOR.

Retain this manual in an easily accessible location for future reference.

Note: Screen displays and illustrations in this manual may differ from the actual ones for better visibility.

Contents

Features	1	Channel Select	18
Cautions for safety	2	Using DIGIT buttons	18
Identification of controls	5	Using CH+/- buttons	18
Front	6	Using previous channel button	18
Back	6	Picture Adjustment	19
Remote Control	7	Sound Adjustment	20
Battery installation	8	Adjusting Sound	20
Effective remote range	8	Adjusting volume	20
Installation	9	Muting the sound.....	20
Antenna installation	9	System Setting	21
Power connection	10	Blue screen	21
Elevation adjustment	10	OSD language	21
Connecting video/audio equipment	11	Colour system	21
Basic operations	13	Sound system	22
Turning on	13	Timer Setting	23
Turning off	13	Use SLP button	23
Selecting input signal	13	Use CLOCK button	23
Menu introduction	14	Operations in AV/S-VIDEO mode	24
Operations in TV mode	15	Operations in PC mode	25
Channel Preset	15	Accessing PC mode	25
Auto Search	15	PC signal format	25
Channel Search	15	Auto adjustment	25
Fine Tuning	16	Adjusting picture	26
Skip Setting	16	Trouble Shooting	27
Channel Edit	17	Specifications	28

Features

Features

- ▶ **TV/Monitor**
- ▶ **High brightness/High contrast LCD**
- ▶ **Resolution: 640 x 480 @ 60Hz**
- ▶ **Brightness: 450 cd/m²**
- ▶ **Contrast Ratio: 350:1**
- ▶ **Multi digital processing & Picture improvement circuit**
- ▶ **English/Chinese on-screen menu display**
- ▶ **Sleep Timer**
- ▶ **Backlight Adjustment**
- ▶ **Channel Edit**
- ▶ **Low power consumption/Low voltage**
- ▶ **PC audio input**
- ▶ **VGA input**
- ▶ **AV input**
- ▶ **S-VIDEO input**
- ▶ **Earphone jack**

Cautions for safety

Cautions for safety

- ◆ When any unusual situation occurs, turn off the power supply at once and remove the plug from the wall outlet. Contact a qualified service department in your local area.

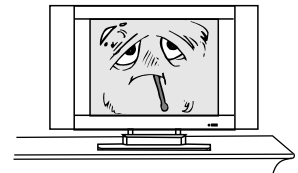

- ◆ Do not expose this unit in the rain or spatter by liquid, Do not use this product near water- for example, near a bathtub, washbowl, kitchen sink, or laundry tub, in a wet basement, or near a swimming pool, and the like. Do not use immediately after moving from a low temperature to high temperature environment, as this causes condensation, which may result in fire, electric shock, or other hazards.



- ◆ 1. Heat sources - Keep the product away from heat sources such as radiators, heaters, stoves other heat generating products (including amplifiers).
- 2. Requirement of environment temperature;
0°C~50°C for storage;
5°C~40°C for working.

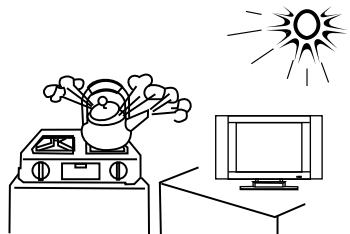

- ◆ 1. The vents and other openings in the cabinet are designed for ventilation. Do not cover or block these vents and openings since insufficient ventilation can cause overheating and/or shorten the life of the product.
- 2. Do not place the product on a bed, sofa, rug or other similar surface, since they can block ventilation openings.
- 3. This product is not designed for built-in installation; do not place the product in an enclosed place such as a bookcase or rack, unless proper ventilation is provided or the the manufacturer's instructions are followed.

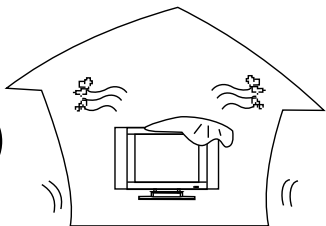

Cautions for safety (continued)

Cautions for safety

- ◆ Unplug this product from the wall outlet before cleaning. Do not use liquid cleaners or aerosol cleaners. Use a damp cloth for cleaning.

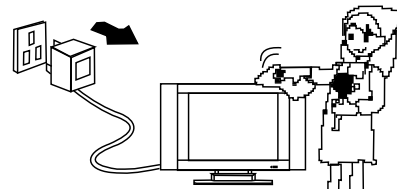

- ◆ 1. Do not place the product on an unstable trolley, stand, tripod or table. Placing the product on an unstable base can cause the product to fall, resulting in serious personal injuries as well as damage to the product.
- 2. Use only a trolley, stand, tripod, and bracket or table recommended by the manufacturer or sold with the product.

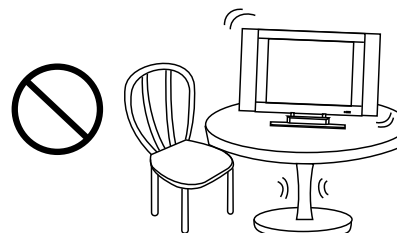

- ◆ When relocating the product placed on a trolley, it must be moved with the utmost care. Sudden stops, excessive force and uneven floor surfaces can cause the product to fall from the trolley.



- ◆ The power cords must be routed properly to prevent people from stepping on them or objects from resting on them. Check the cords at the plugs and product. Power supply cords should be routed so that they are not likely to be walked on or snagged by items placed upon or against them. Pay particular attention to cords at doors, plugs, receptacles, and the point where they exit from the product. If the power cord or the plug is damaged contact a qualified service department for service.

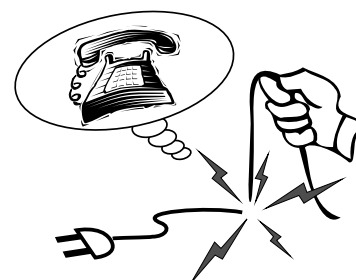

⚠ This TV set can operate on a power of ~240V, 50Hz. You must not use any other type of power supply.

◆ Do not overload wall outlets, extension cords, or convenience receptacles on other equipment as this can result in a risk of fire or electric shock.

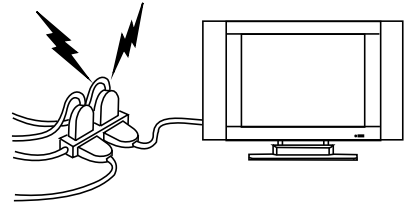

◆ High Voltage exists in this TV set. Do not remove the cover. In case the product needs replacement parts, make sure that the service person uses replacement parts specified by the manufacturer, or those with the same characteristics and performance as the original parts. Use of unauthorised parts can result in fire, electric shock and/or other danger.



◆ The LCD panel used in this product is made of glass. Therefore, it can break when the product is dropped or impacted upon by other objects. Be careful not to be injured by broken glass pieces in case the LCD panel breaks.

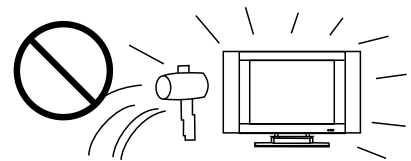

◆ Don't try to push anything into the cabinet or place any vessel with water on the TV set.

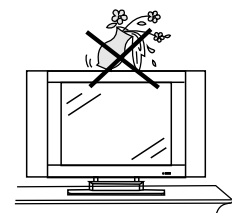

◆ During a lightning storm, or when it is left unattended and unused for long periods of time, unplug it from the wall outlet and disconnect the antenna. This will prevent damage to the equipment due to lightning and power-line surges.

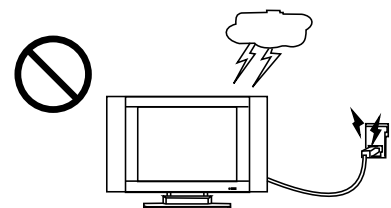

Identification of controls

Front/Back

Front

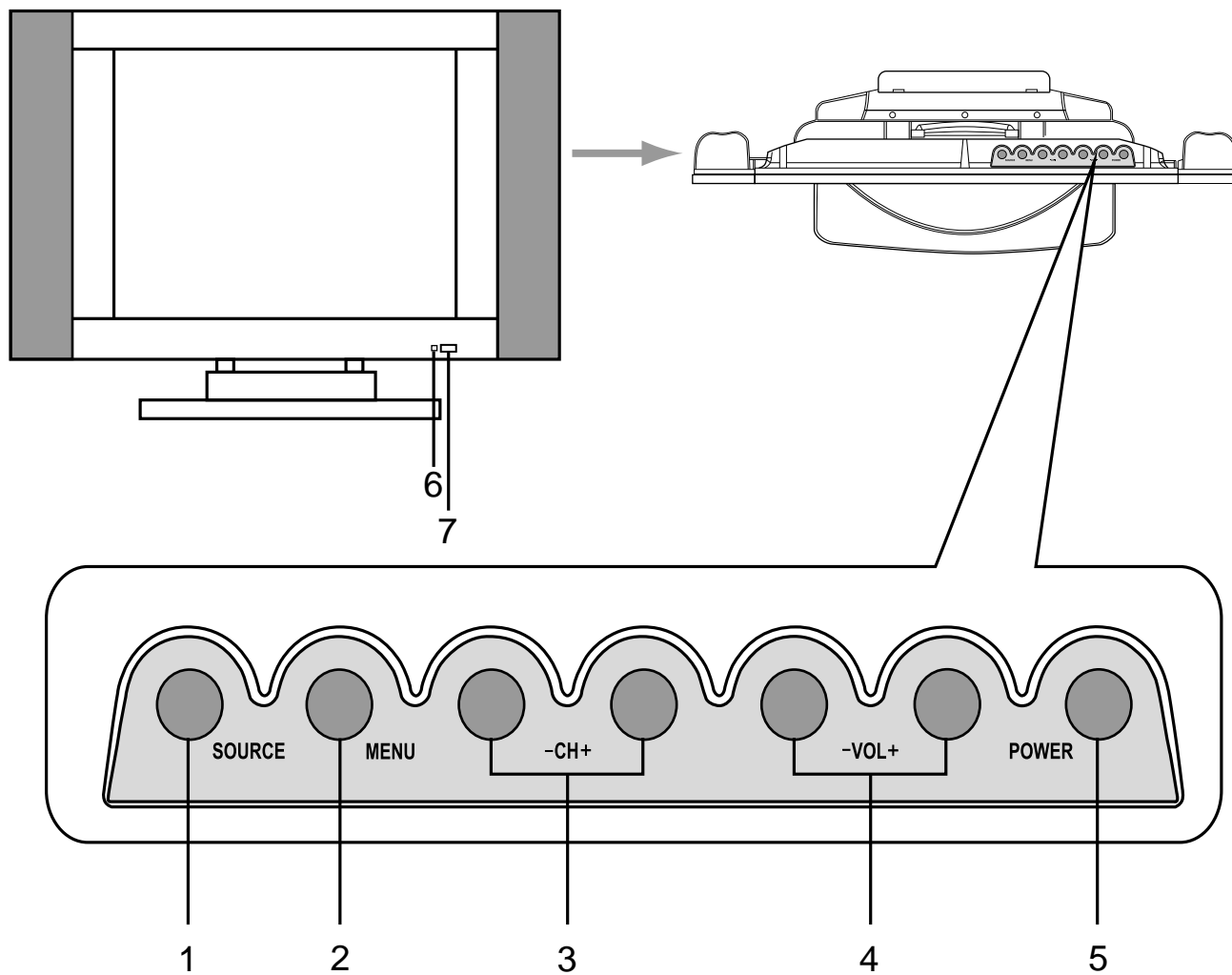

1. To input signal select
2. To access menu
3. CH+/-: to select a higher/lower numbered channel or cycle through the menus.
4. VOL+/-: press to raise/lower the volume or adjust the selected item.
5. Power on/standby
6. Indicator: standby mode: red
power on: yellow
7. Remote sensor

Back

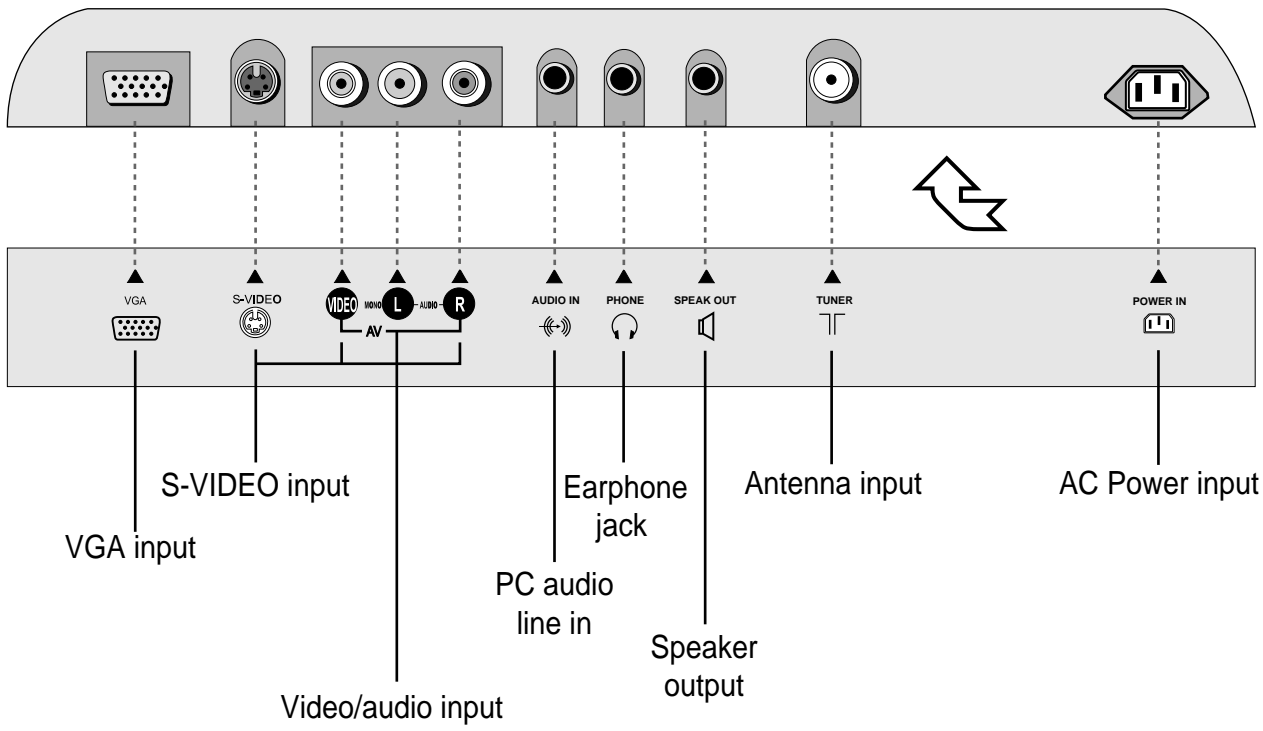
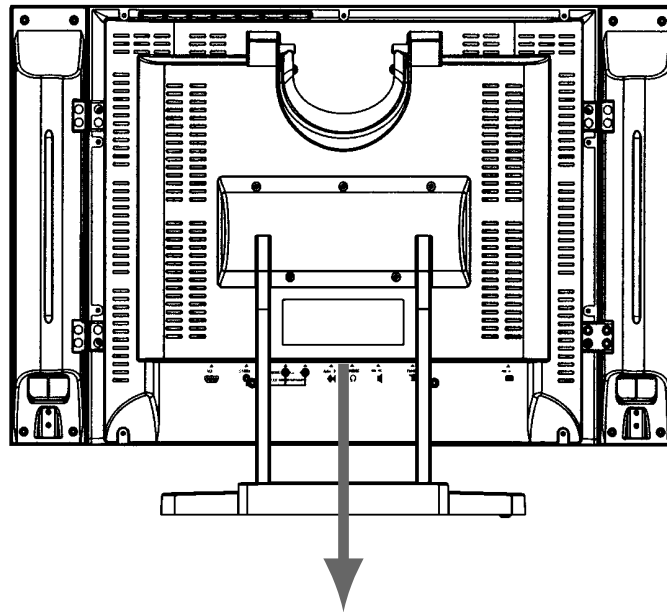

Remote control

Remote control

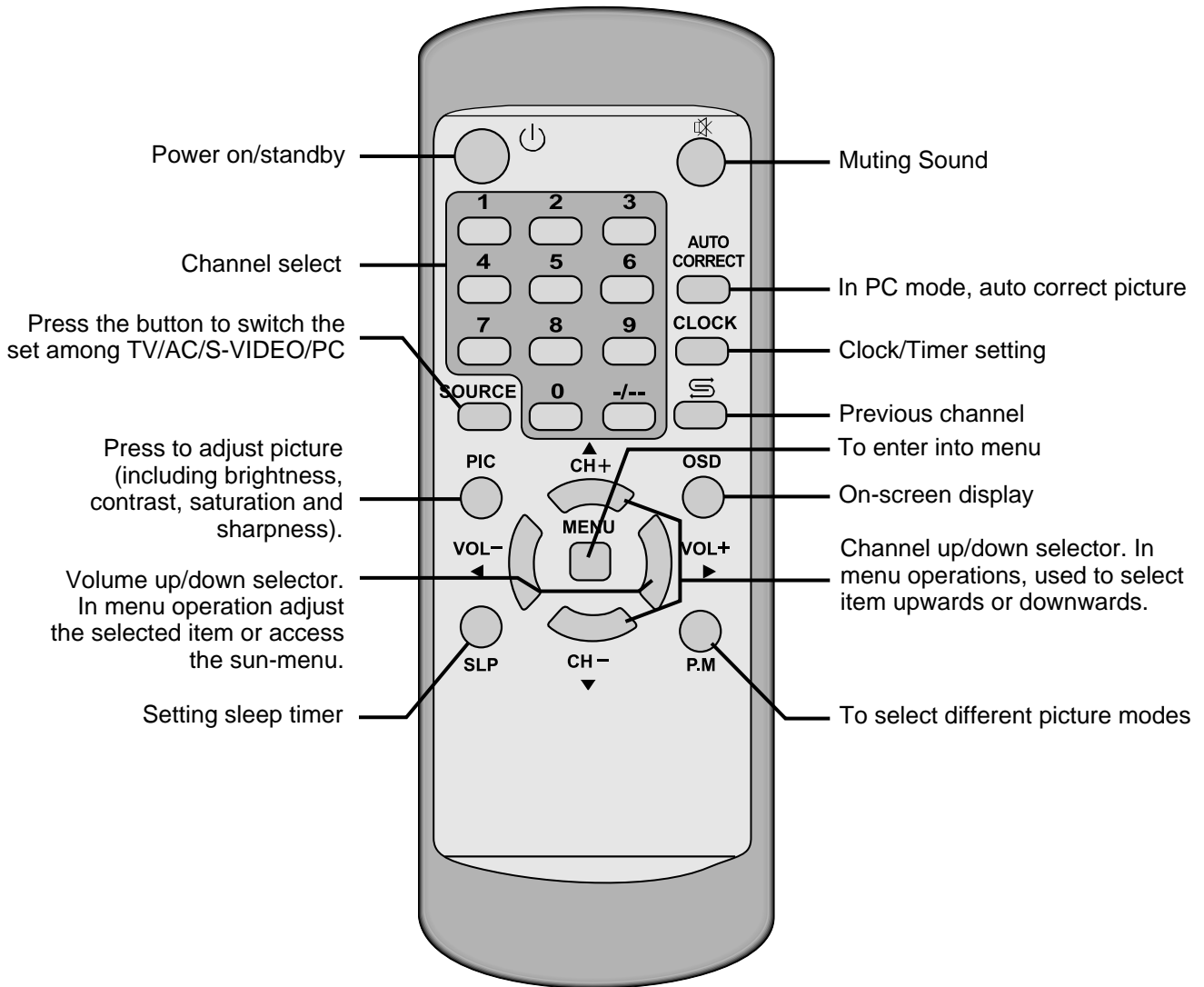

Battery Installation

Please install the batteries before using the remote control.

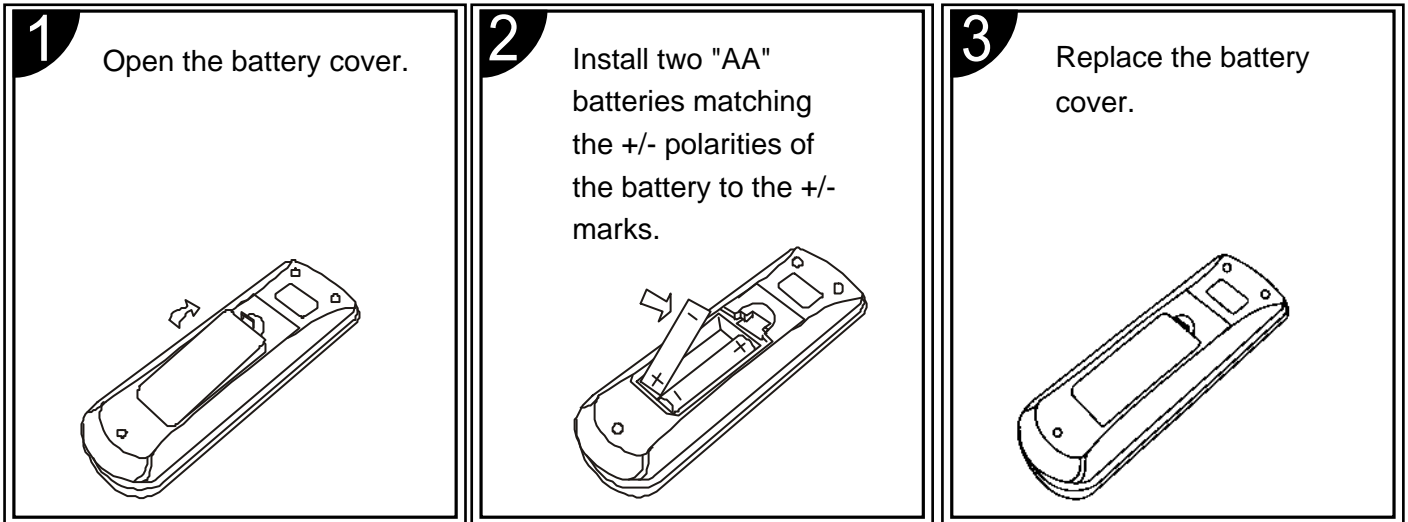

Effective remote range

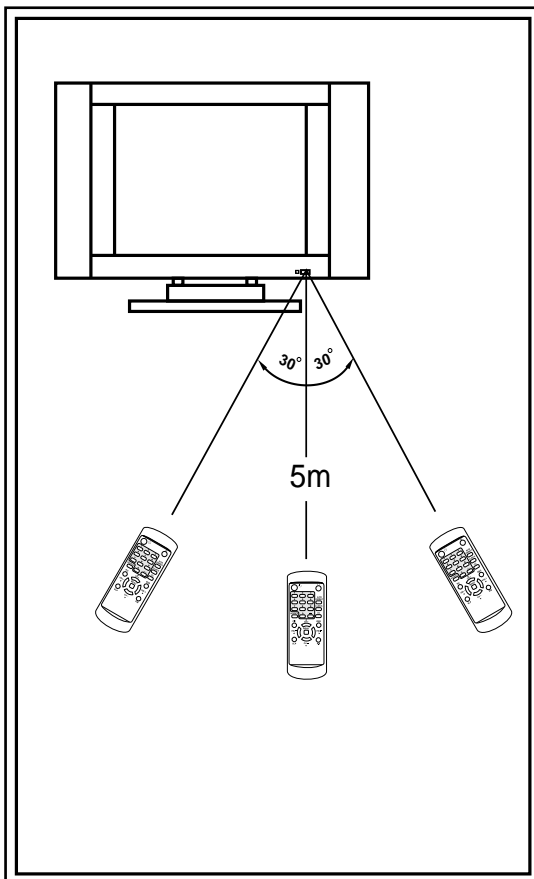

! Notes:

1. When the remote control will not be used for a long period of time or when the batteries are worn out, remove the batteries.
2. Do not drop, dampen the remote control.
3. Do not disassemble the remote control.
4. There should be no obstacle between the TV and the transmitter.
5. Use the remote control within the effective range as the left figure.
6. If the remote control does not work, please check whether the batteries are exhausted or the polarity is wrong.
7. When direct sunlight, and incandescent lamp, fluorescent lamp or any other strong light shines on the remote sensor of the TV, the remote operation may be unstable.
8. Different batteries have different features. Please don't mix different- type batteries.

Installation

Antenna connection/Power connection/Elevation adjustment

Antenna connection

Optimum reception of colour requires a good signal and will generally mean that an outdoor aerial must be used. The exact type and position of the aerial will depend upon your particular area.

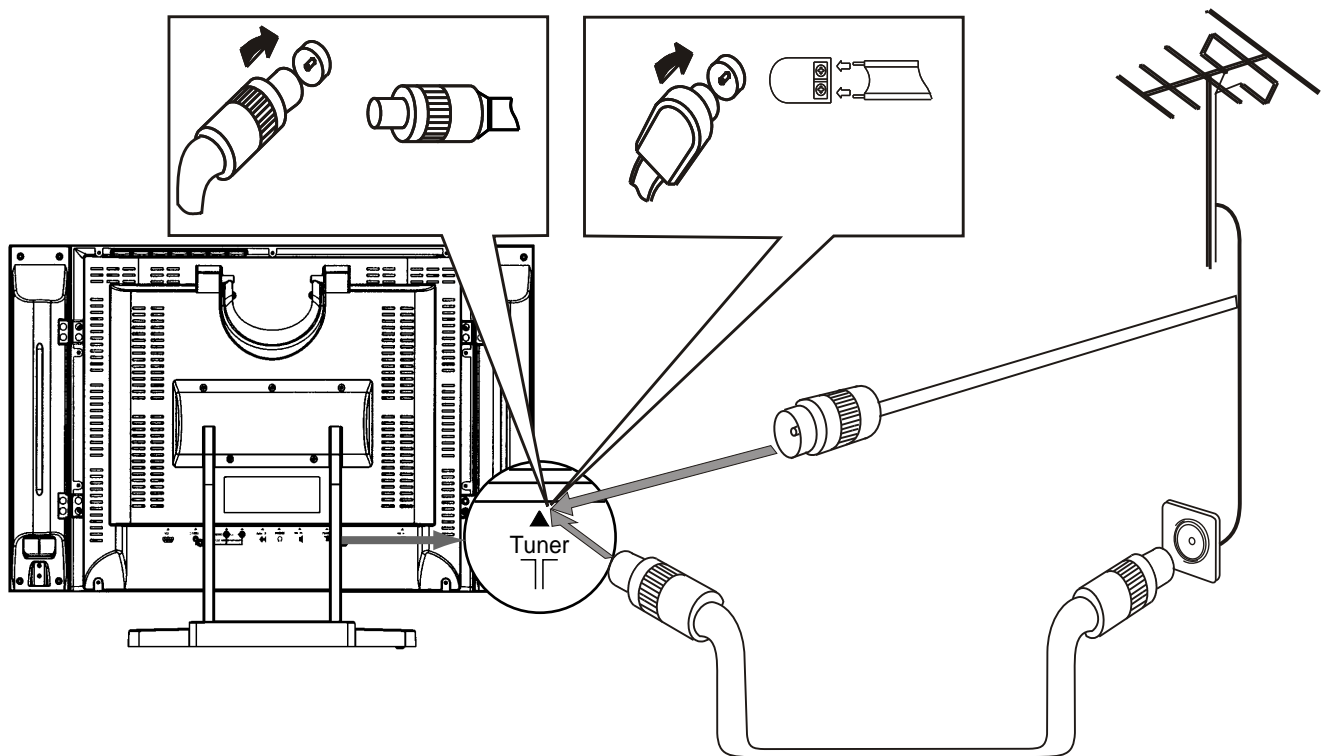

! Notes:

Turn off the power firstly when you connect an outdoor antenna to the antenna input terminal. When installing an outside antenna system, extreme care should be taken to keep from touching power lines or circuits as contact with them might be fatal. In thunder and lightning weather, please disconnect the outdoor antenna to avoid thunder/lightning strike.

Power Connection

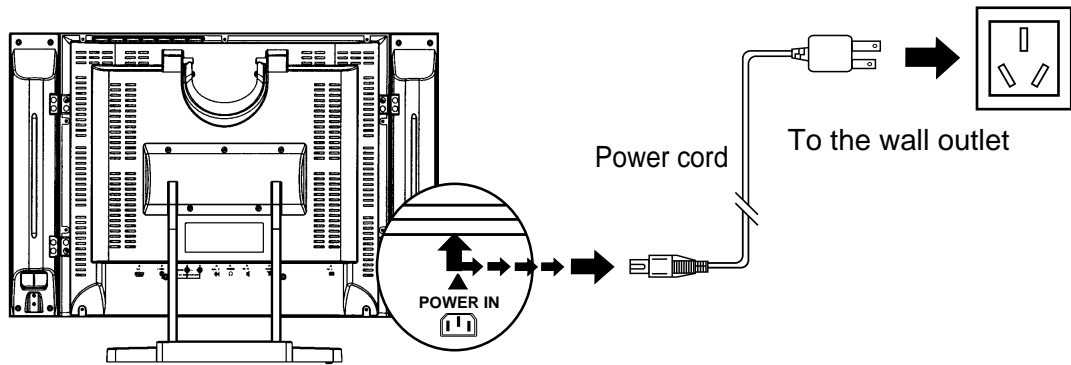

! Notes:

1. This TV can only be operated on a power of AC 240V 50 Hz.
2. Please remove the power plug from the wall outlet when the TV will not be used for a long period of time.

Elevation adjustment

You can adjust the angle of the LCD TV as follows.
The elevation can be adjusted from -5° to $+15^{\circ}$.

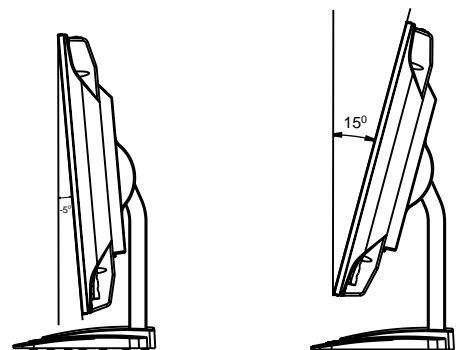

Installation (continued)

Connecting video/audio equipment

Connecting video/audio equipment

Composite VIDEO Signal Connection (RCA)

Connect the composite signal terminal on the TV to the output of AV equipment through composite cable as illustrated.

If you select the video signal, please set the input signal source to AV mode (please refer to page 13).

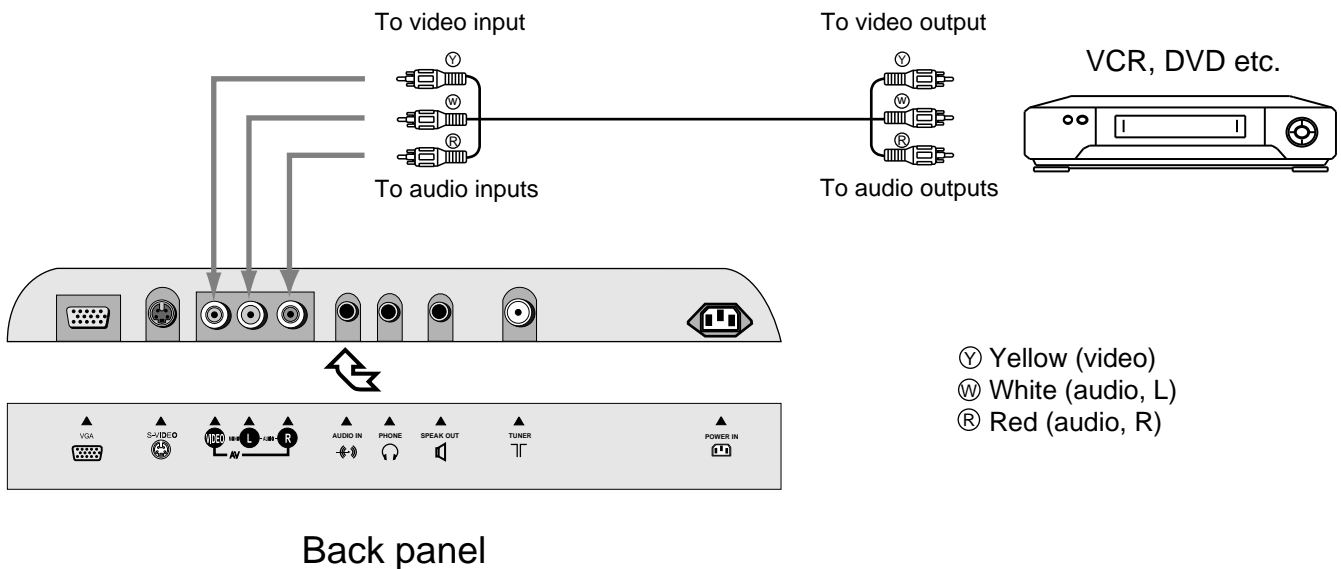

S-VIDEO Signal Connection

Connect the S-video terminal on the TV to the output of AV equipment through S-video cable as illustrated.

If you select S-video signal, please set the input signal source to S-video mode (please refer to page 13).

- ❗ 1. Carefully check the terminals for position and type before making any connections.
- 2. Loose connectors can result in image or colour problems. Make sure that all connectors are securely inserted into their terminals.
- 3. When connecting an external device, turn off the power of the main unit first to prevent any possible damage.

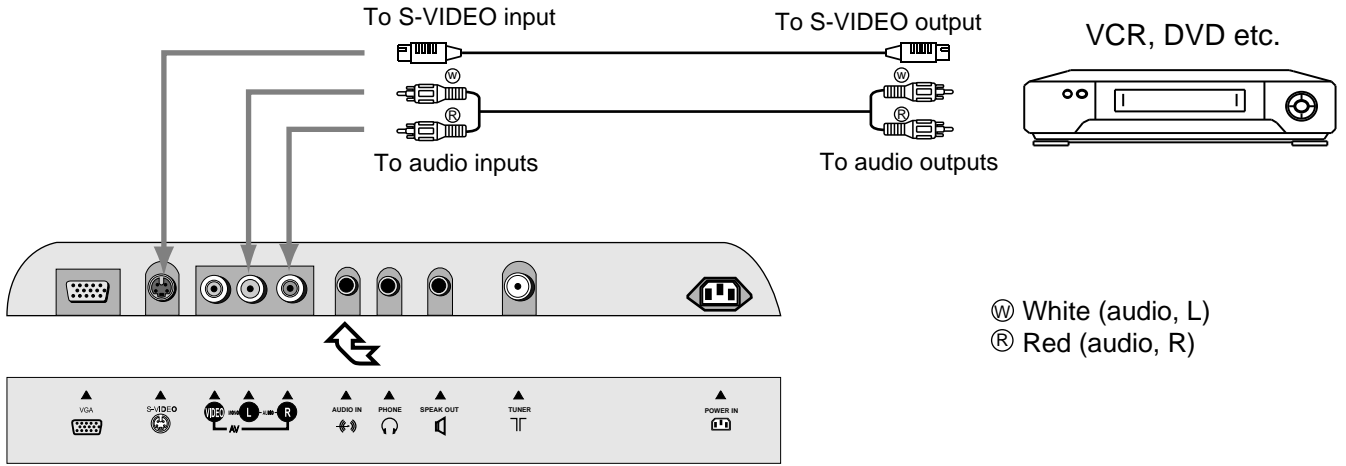

Connecting the PC input terminals

Connect the D-sub signal terminal on the TV to the output of PC equipment through Min D-sub 15 pin cable as illustrated. Connect a cable, which matches the audio output terminal on the computer. If you select PC signal, please set the input signal source to PC mode (please refer to page 13).

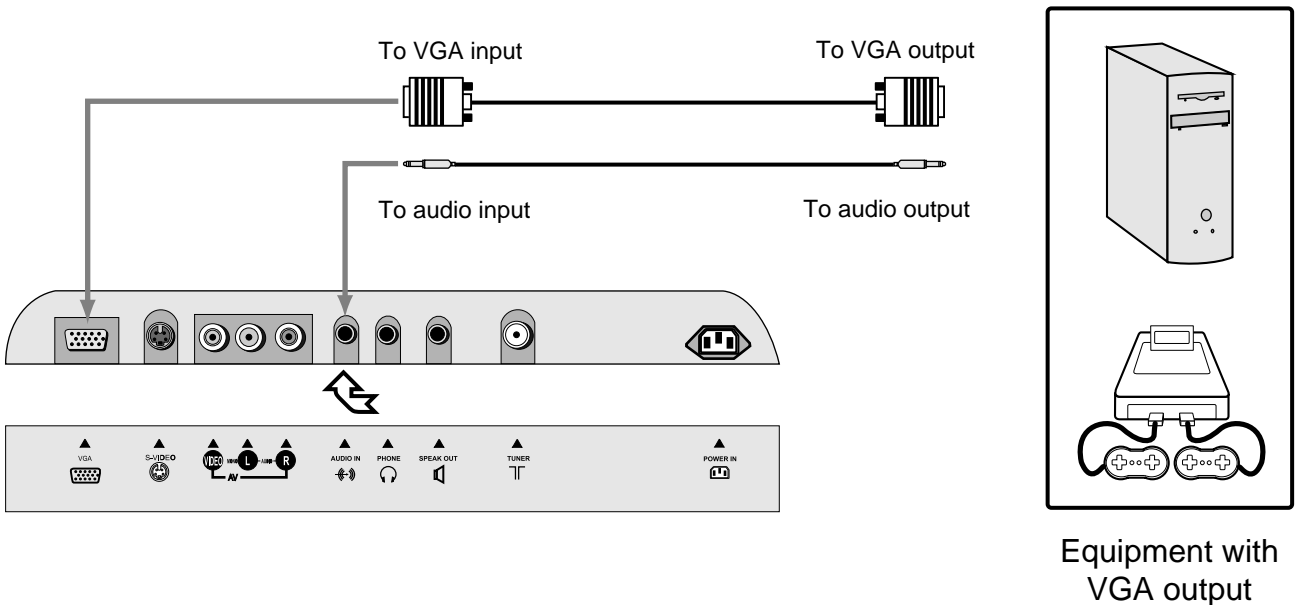

❗ Notes:

1. The display native resolution is 640 x 480. If the signal resolution exceed the native resolution, it may not be possible to show fine detail with sufficient clarity.
2. We recommend that you do not set the vertical scanning frequency for PC signals to exceed 60Hz otherwise it maybe display incorrectly.

Basic operations

Turning On/Turning Off/Selecting input signal/Menu introduction

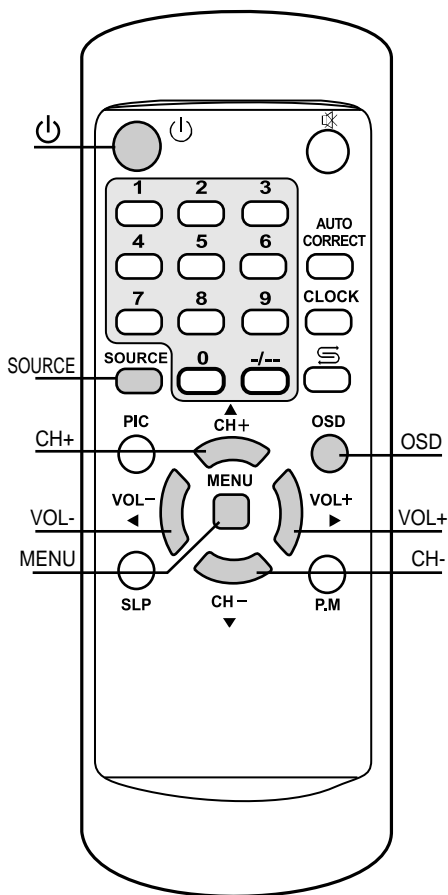
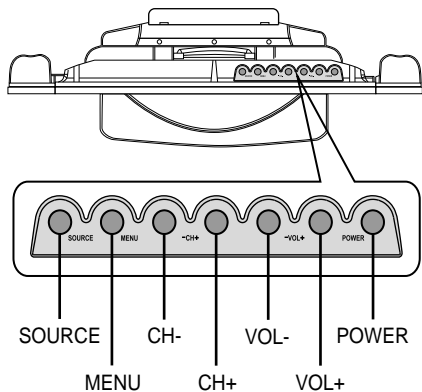

Turning On

- 1 Insert the power plug to wall outlet, then the red indicator lights up and the unit is in STANDBY mode.
- 2 Press the **POWER** button on the unit's control panel or the  button on the remote control to turn on (the indicator turns to yellow).
- 3 The TV will display the program before turning off last time.

Turning Off

Press the **POWER** on the unit or the button  on the remote control again. Then the TV is in STANDBY mode. The indicator turns to red.

This TV set can automatically turn off (standby) by Sleep timer.

Note:

Please unplug the power cord from the wall outlet if not in use.

Selecting input source

- 1 Press the **SOURCE** button on the unit or on the remote control. The screen displays **AV/S-Video/PC/TV**. Select your desired input signal.
- 2 To resume TV mode, press the **SOURCE** button on the unit or on the remote control repeatedly until the screen displays TV. You can also press digit buttons or **CH+/-** buttons to resume TV mode.
- 3 Press **OSD** button, the screen displays current mode. Press again to cancel OSD.

 **Note:** All buttons in the manual are buttons on remote control if without special indication.

Menu introduction

In TV mode, there are three menu pages. In MENU operations, the **CH+/-** buttons are used to select item (selected item will turn to white), the **VOL+/-** buttons are used to adjust or confirm selected item. But in PC mode, only one menu can be accessed.

During MENU operation process, pressing **MENU** button repeatedly or waiting for 5 seconds can exit menu.

Press **MENU** button

	Bright	50		+	To adjust picture's brightness.
	Contrast	100		+	To adjust picture's contrast.
	Saturation	80		+	To adjust picture's colour saturation.
	Sharpness	3		+	To adjust picture's sharpness.
	Color Hue			+	To adjust picture's colour hue.
	Backlight	Bright			(This item is available only in NTSC) To adjust picture's backlight (Nature, Bright, Soft).

Press MENU button

Press **MENU** button twice

	Blue Background Disable				To select the screen to display blue background or not when no signal inputs.
	Language	English			To select OSD menu language.
	Color Sys	Auto			To adjust colour system.
	Sound Sys	B/G			To adjust sound system. (In AV or S-Video mode, the item is grey and you can not select it).
	Sound Set	→			

	Bass	6		+	To adjust the Bass
	Treble	9		+	To adjust the Treble

Press MENU button

Press **MENU** button third time

	Auto search	→			To start auto search.
	Fine tuning	⇨			To enter into fine tuning menu.
	Channel search	⇨			To enter into channel search menu.
	Skip setting	⇨			To skip current channel or not.
	Channel edit	⇨			To exchange current channel with the selected target channel.

Note: In AV or S-Video mode, the menu is not accessible.

Press **MENU** button in PC mode

	Bright	50		+	To adjust picture's bright and contrast in PC mode. (not affect picture in TV or AV mode)
	Contrast	50		+	
	Horizontal	50		+	If VGA input signal is not standard, you can adjust these two items until proper picture position is obtained.
	Vertical	50		+	
	Phase	9		+	If the best picture can not be obtained after many times of auto correction, you can adjust these two items to obtain the best picture.
	Frequency	1334		+	
	Color	9300K			To adjust colour temperature between 9300K 7300K 6500K, 5000K and User.
	Backlight	Bright			To adjust backlight. (Nature, Bright, Soft)

Note: In PC mode, only this menu can be accessed.

Operations in TV mode

Channel preset

Auto search/Channel search/Fine tuning/Skip setting

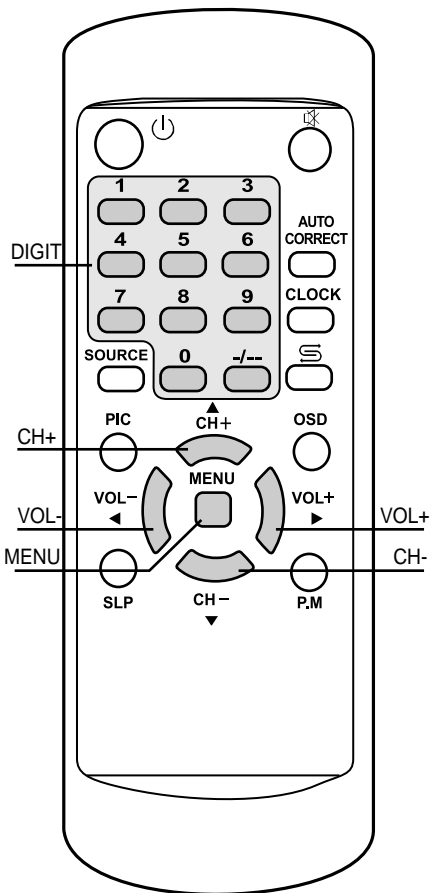
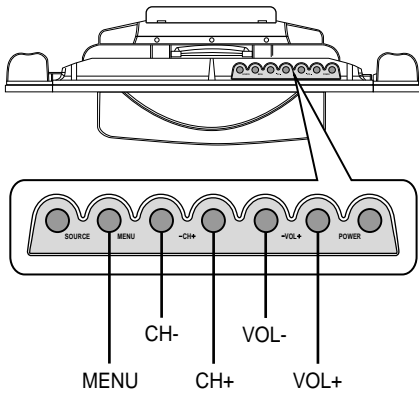

Auto search

- 1 Press **MENU** button third times to access menu (Refer to **Menu introduction** on page 14).
- 2 Press **CH+/-** to select **Auto search** item.
- 3 Press **VOL+/-** buttons to start Auto search and all active programs will be memorised.
During the process of Auto Search, pressing **MENU** button can stop Auto Search.

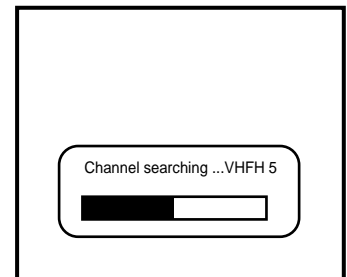
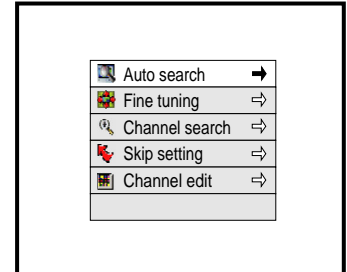

If desired channel can not be preset by Auto search or if you would like to preset channels to specific position numbers one by one, use **Channel search** function.

Channel search

- 1 Press **DIGIT** buttons or **CH+/-** buttons to select desired channel number.
- 2 Press **MENU** button third times to enter into menu (refer to **Menu introduction** on page 14).
- 3 Press **CH+/-** to select **Channel search** item. Press **VOL+/-** buttons to access the sub-menu, then press **VOL+/-** to start Channel search.

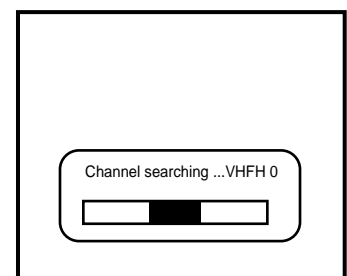
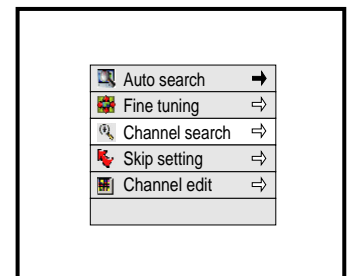

Pressing **MENU** button can exit **Channel search** sub-menu.

! To conduct the following operation, you must select TV input signal
(Refer to **Selecting input signal** on page 13).

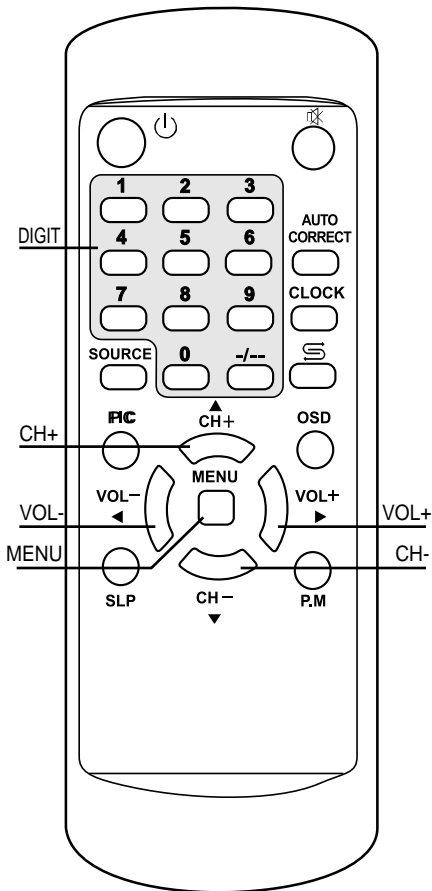
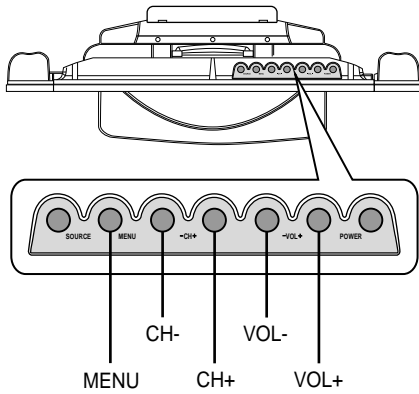

Fine tuning

- 1 Press **DIGIT** buttons or **CH+/-** buttons to select the desired channel.
- 2 Press **MENU** button third times to access menu. (refer to **Menu introduction** on page 14).
- 3 Press **CH+/-** to select **Fine tuning** item. Press **VOL+/-** to access the sub-menu. Then press **VOL+/-** to start Fine tuning to obtain best picture and sound.

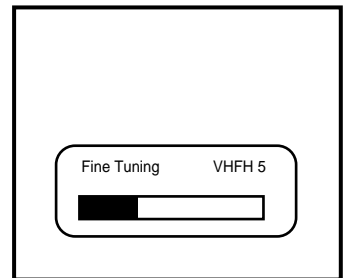
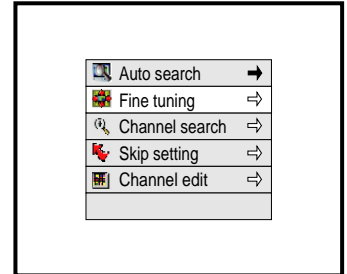

Skip setting

After Channel preset, You can skip unwanted channels by using this function.

- 1 Use **DIGIT** buttons or **CH+/-** buttons to select an unwanted channel.
- 2 Press **MENU** button third times to access the menu. (refer to **Menu introduction** on page 14).
- 3 Press **CH+/-** buttons to select **Skip setting** item. Press **VOL+/-** buttons to access the sub-menu. Press **VOL+/-** to select **Skip**. Now the channel will be skipped when you browse program by **CH+/-**.
- 4 To restore the skipped channel, please select the skipped channel by **DIGIT** buttons and then access the **Skip Set** sub-menu to set **skip** to **save**.

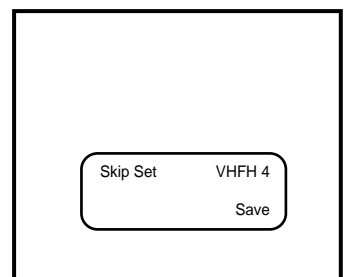
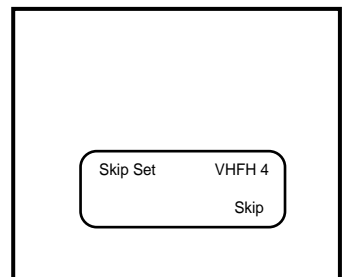
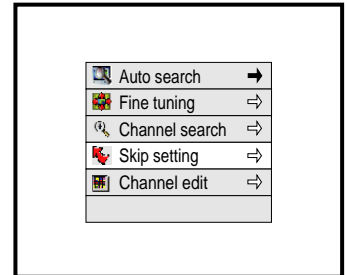

Operations in TV mode (continued)

Channel preset

Channel edit

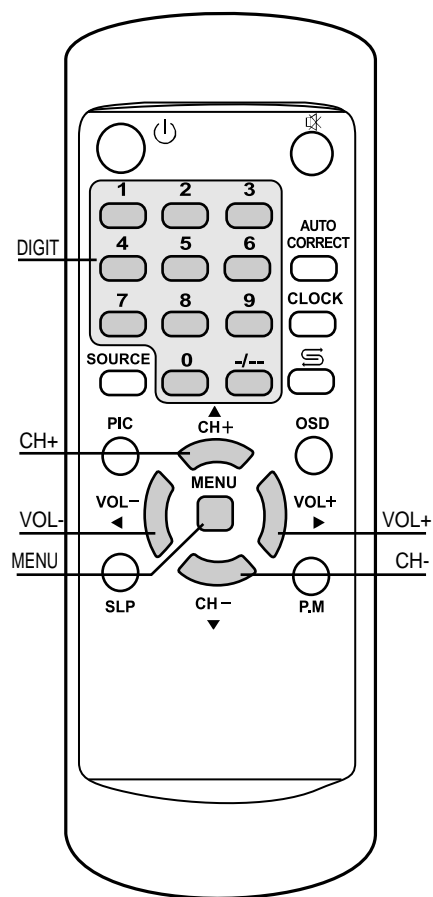
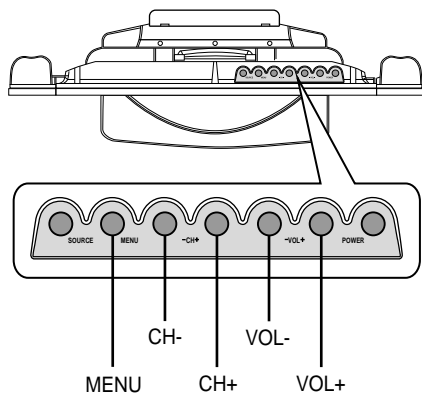

Channel Edit

After Auto Channel Preset, this function is for you to edit the order of programs conveniently according to your favourite.

- 1 Use **DIGIT** buttons or **CH+/-** buttons to select current channel number.
- 2 Press **MENU** button third times to access menu (refer to **Menu introduction** on page 14).
- 3 Press **CH+/-** buttons to select **Channel edit** item. Press **VOL+/-** buttons to access the sub-menu. Press **CH+/-** buttons to select a target channel to exchange with current channel. Exiting the menu, then the programs of these two channels are exchanged.

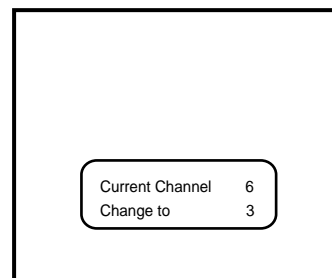
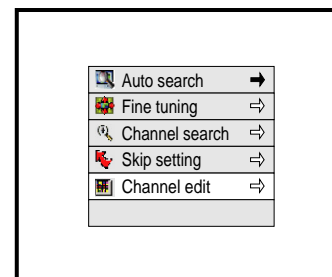

Channel Select

Using DIGIT buttons/Using CH+/- buttons/Using previous channel button

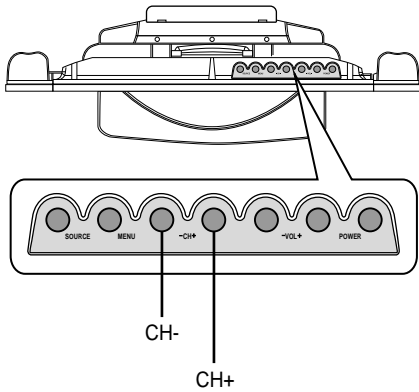

Using DIGIT buttons

- 1** To select one-digit channel number:
Press **0-9** digit buttons to select the desired channel. Two seconds later, the channel is selected.
- 2** To select two-digit channel number:
Press **-/--** button repeatedly to display **--** on the screen.
Press **1-9** buttons to select tens digit. Press **0-9** buttons to select ones digit (The period of the two presses must be within 2 seconds). Two seconds later, the channel is selected.

Using CH+/- buttons

- 1** Press **CH+** button, the channel number increases;
- 2** Press **CH-** button, the channel number decreases.

Using previous channel button

Press  button to switch between the current channel and previous channel.

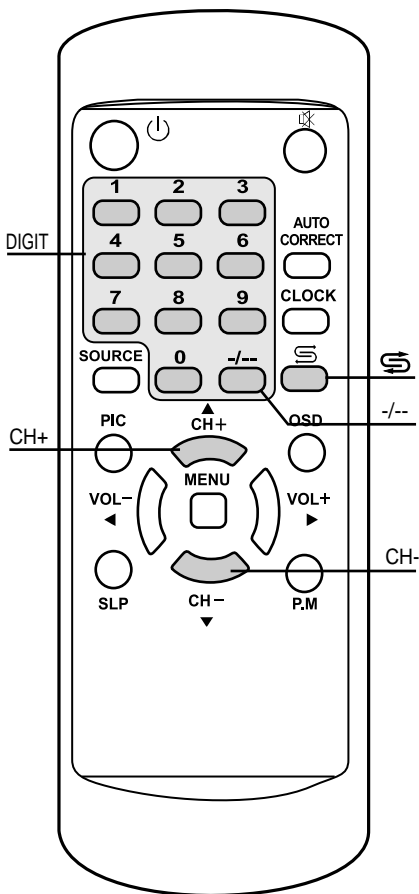

Operations in TV mode (continued)

Picture adjustment

Picture adjustment

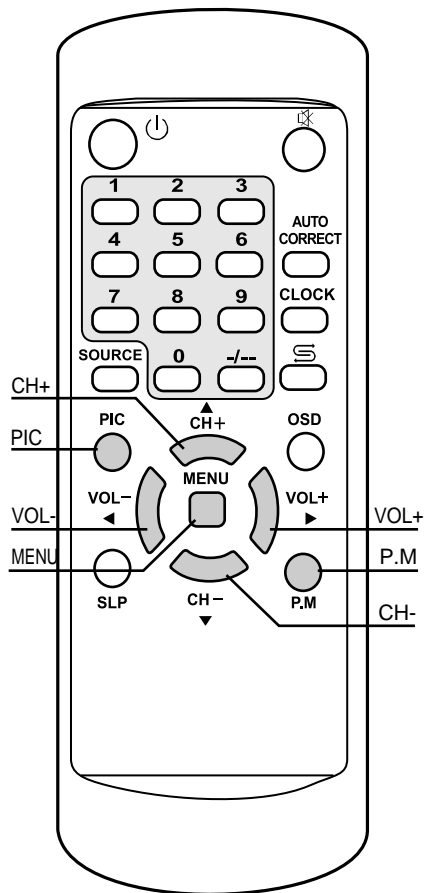
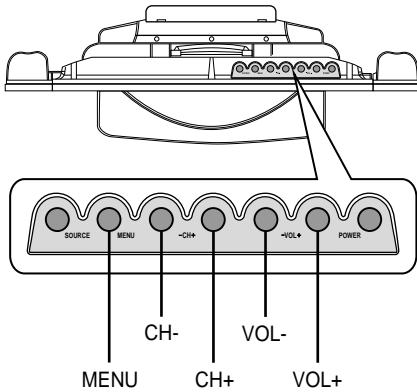

1 Press **MENU** button once to access the menu (refer to **Menu introduction** on page 14).

2 Press **CH+/-** to select item.

3 Press **VOL+/-** to adjust selected item.

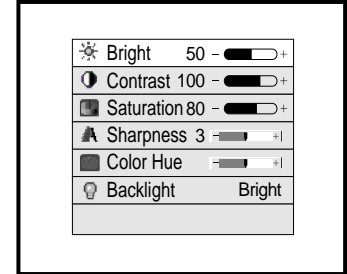

Item	Function	Range
Bright	To adjust picture's brightness	0-100
Contrast	To adjust picture's contrast	0-100
Saturation	To adjust picture's colour saturation	0-100
Sharpness	To adjust picture's sharpness	0-6
Colour Hue	To adjust picture's colour hue	0-100
Backlight	To adjust the backlight	Soft, Nature, Bright

! **Note:** The item **Colour Hue** is for NTSC only.

You can access **Brightness** menu, **Contrast** menu, **Saturation** menu, **Sharpness** menu by pressing **PIC** button directly and adjust brightness, contrast, saturation, sharpness with **VOL+/-** buttons.

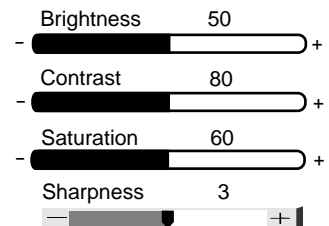

You can select picture mode by **P.M** button. There are four picture modes: **Bright**, **Nature**, **Soft** and **User mode**.

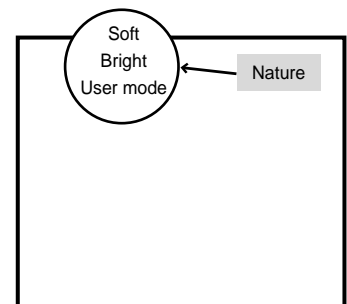

Sound adjustment

Adjusting sound/Adjusting volume/Muting the sound

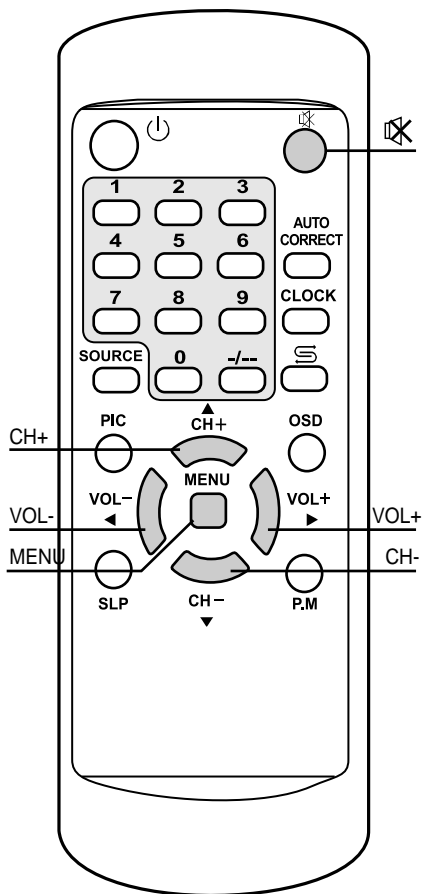
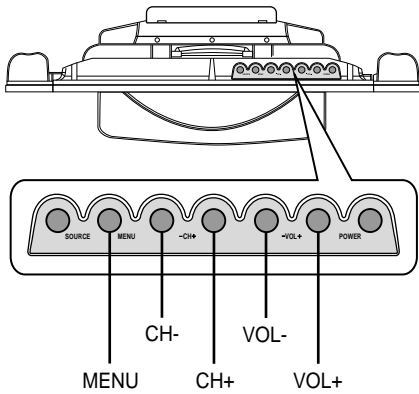

Adjusting sound

- 1 Press **MENU** button twice to access the menu (refer to **Menu introduction** on page 14).
- 2 Press **CH+/-** to select **Sound Set** item.
- 3 Press **VOL+/-** to access the sub-menu. Press **CH+/-** to select item and press **VOL+/-** to adjust the selected item.

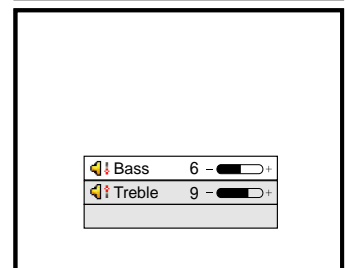
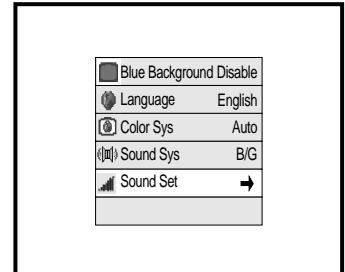

Item	Function	Range
Bass	Adjust bass	0-10
Treble	Adjust treble	0-10

Adjusting volume

Press **VOL+/-** to adjust volume. Press **VOL+** button, the volume increases. Press **VOL-** button, the volume decreases (**Range 0-45**).

Volume - + 30

Muting the sound

If you want to mute the sound, press button on the remote control. Press button again to restore. You can also press **VOL+** or **VOL-** to restore the sound.



Operations in TV mode (continued)

System Setting

Blue screen/OSD Language/Colour system/Sound system

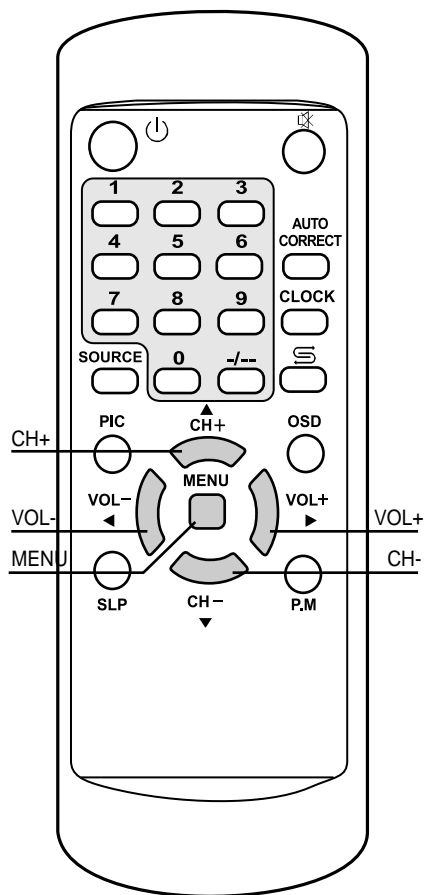
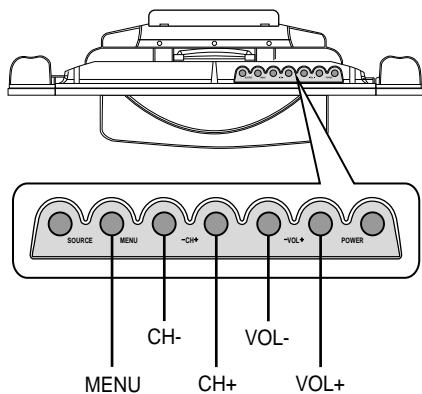

Blue screen

- 1 Press **MENU** button twice to access the menu (refer to **Menu introduction** on page 14).
- 2 Press **CH+/-** to select **Blue Background** item.
- 3 Press **VOL+/-** to select **Enable** or **Disable**. If you select **Enable**, the screen displays blue background when there is no signal. If you select **Disable**, the screen displays noisy picture when there is no signal.

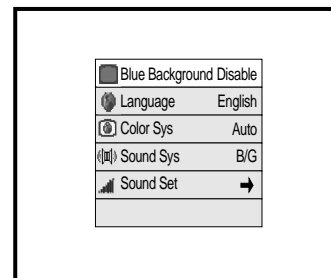

! Note: Only when the Blue screen is Enable, the set would be turned off automatically when there is no signal for 15 minutes.

ODS language

- 1 Press **MENU** button twice to access the menu (refer to **Menu introduction** on page 14).
- 2 Press **CH+/-** to select **Language** item.
- 3 Press **VOL+/-** to select language.

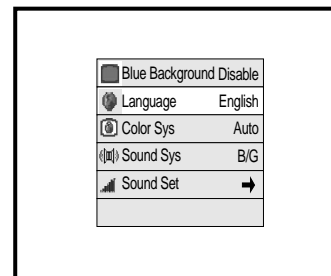

Colour system

- 1 Press **MENU** button twice to enter into menu (refer to **Menu introduction** on page 14).
- 2 Press **CH+/-** to select **Color Sys** item.
- 3 Press **VOL+/-** to select a proper colour system according to your area.

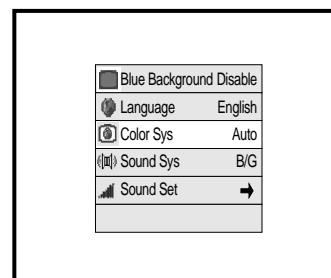

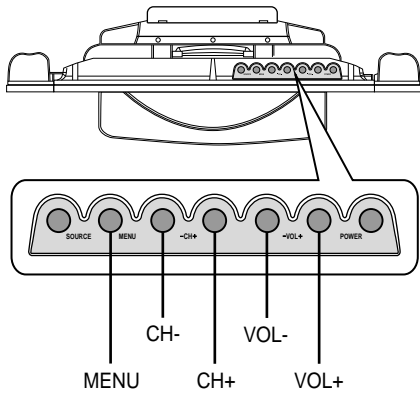

Sound system

- 1 Press **MENU** button twice to access the menu (refer to **Menu introduction** on page 14).
- 2 Press **CH+/-** to select **Sound sys** item.
- 3 Press **VOL+/-** to select correct sound system according to your area.

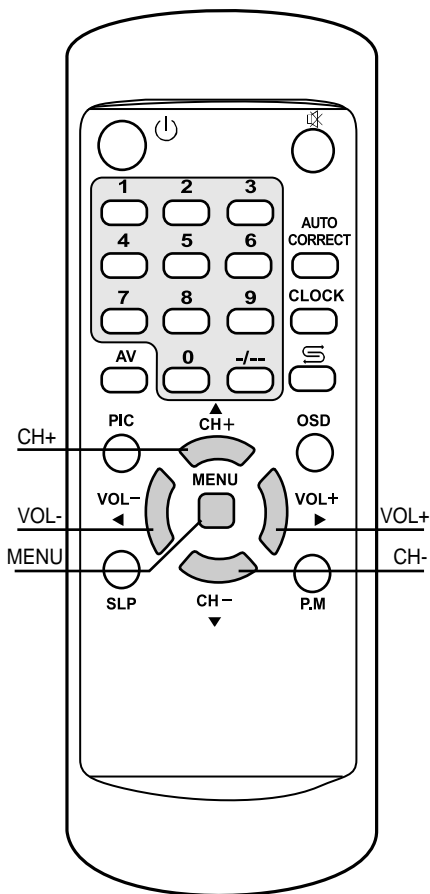
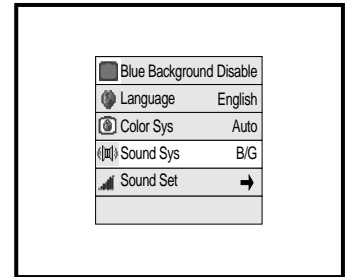

Some models are with only one sound system and in this case the Sound System does not need to be adjusted.

Operations in TV mode (continued)

Timer setting

Using SLP button/Using CLOCK button

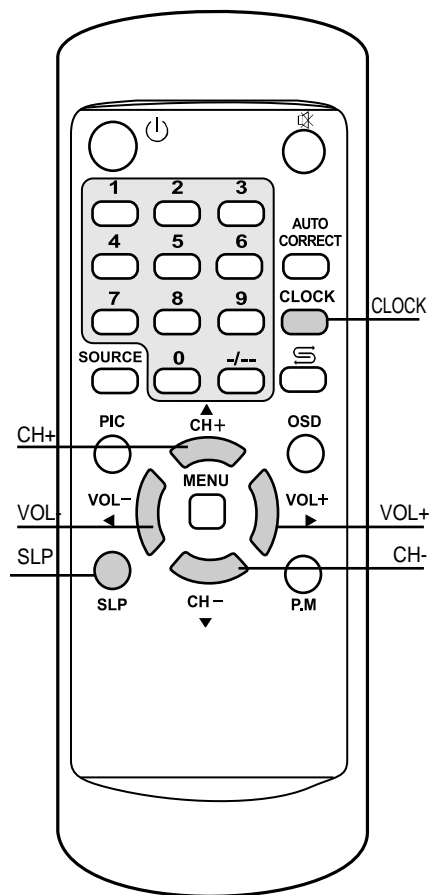
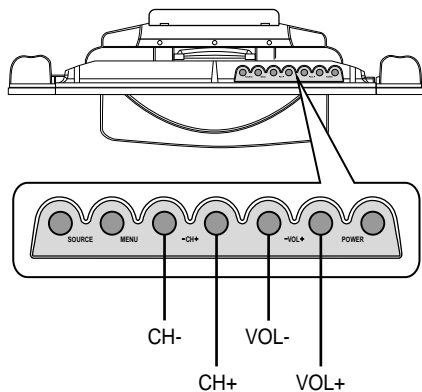

Using SLP button

Press **SLP** button to display **Sleep** menu. Press **SLP** button repeatedly to set sleep time between: 0, 10, 20, 30, 60, 90, 120, 180, 240 minutes. If you select 0 minute, it means the sleep timer function is turned off.

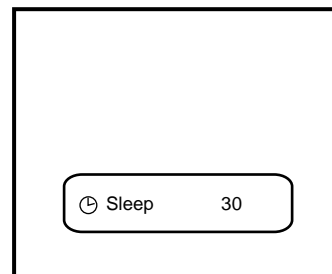

Using CLOCK button

1 Press **CLOCK** button, the Time menu appears. Use **CH+/-**, **VOL+/-** to set time.

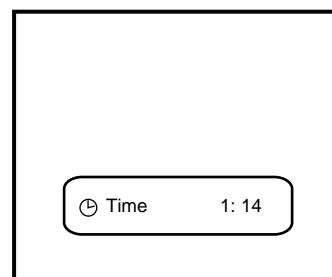

2 After setting **Time** menu, press **CLOCK** button to display **Turn on** menu. Press **CH+/-** to select item (hour, minute, status, the selected item is displayed in blue). Press **VOL+/-** to adjust **Turn on** time and **Turn on** status (OFF, Today, Everyday).

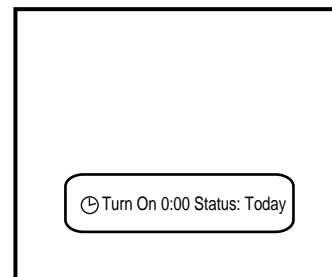

Today: means the **Turn on** setting effects today.
 Everyday: means the **Turn on** setting effects everyday.

3 Press **CLOCK** again to display **Turn off** menu. The operation is same to **Turn on** setting.

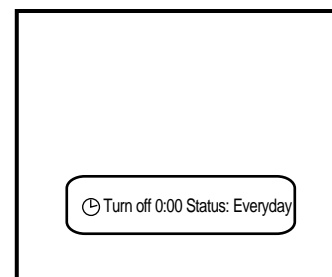

Operations in AV/S-VIDEO mode

Operations in AV/S-VIDEO mode

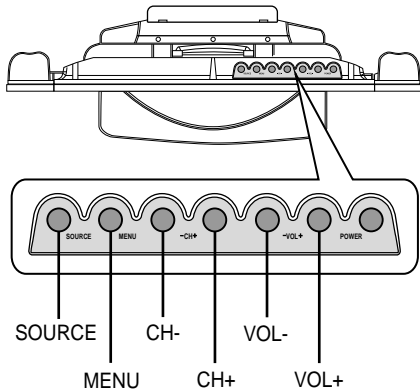

You can connect the set to video tape recorder, VCD, DVD, or other equipment with AV, S-VIDEO output to watch the program from them (refer to **Connecting video/audio equipment**).

Firstly, the TV set must be in AV/S-VIDEO mode (refer **Selecting input signal** on page 13).

In AV/S-VIDEO mode, for menu operation please refer to **Operations in TV mode**.

In AV/S-VIDEO mode, it is unnecessary to preset channel and set sound system, so the channel preset menu is inaccessible and the sound system can not be adjusted.

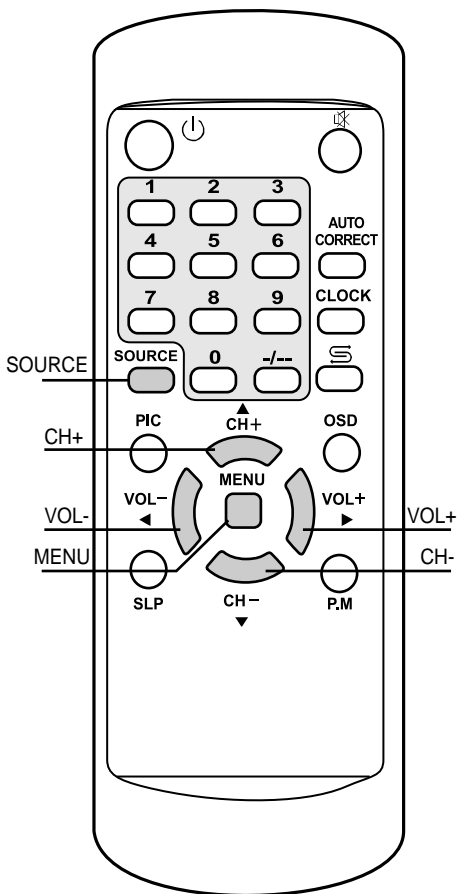

Operations in PC mode

Accessing PC mode/PC signal format/Auto adjusting/Picture adjustment

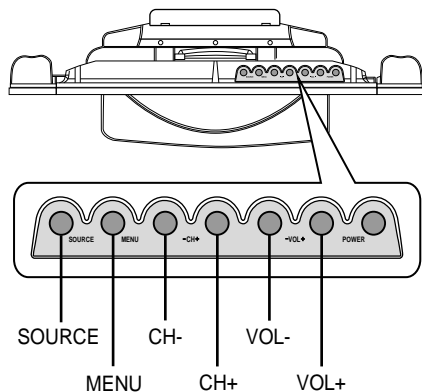

Accessing PC mode

Press **SOURCE** button on the unit or on the remote control repeatedly until the screen displays **PC**, which indicates that the set is in PC mode (refer to page 13). If you connect the set to PC equipment, be sure the set is in PC mode.

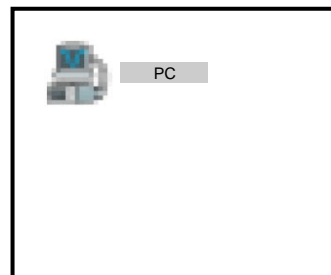

In PC mode, if no PC signal is inputted, the screen will display the information as illustrated.

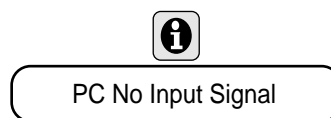

PC signal input

Please connect VGA input and be sure that there is VGA input signal. The signal format should be: 640 x 480 @ 60Hz.

Auto adjusting

When PC signal format changes or when you switch to PC mode by pressing **SOURCE** button, the set adjusts frequency and phase automatically to obtain the best display. During the process of auto correction, the screen displays **Adjusting Signal**, and all buttons on the set and on the remote control do not work until this process is finished.

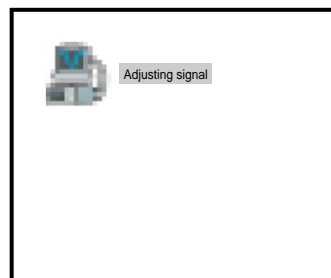

When the set displays some nonstandard VGA signals and can not adjust the picture to the best status by itself, you can adjust it again by pressing the **AUTO.CORRECT** button on the remote control.

When the input signal is correct, press **MENU** button and it will display PC menu.

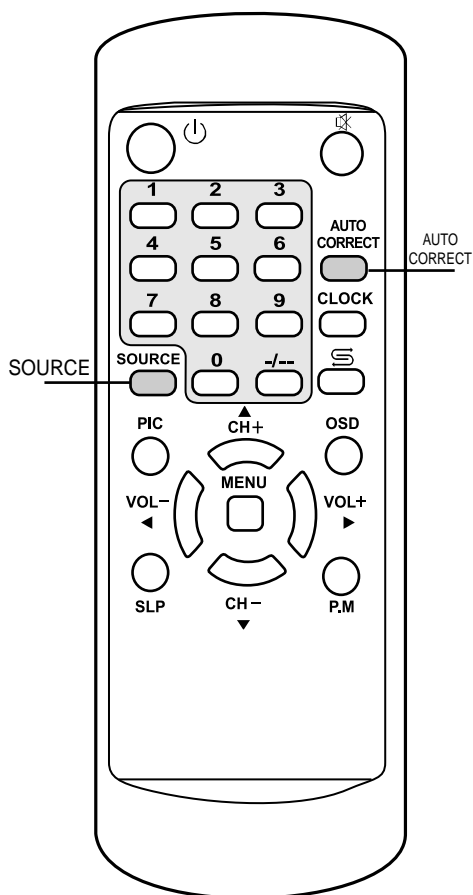

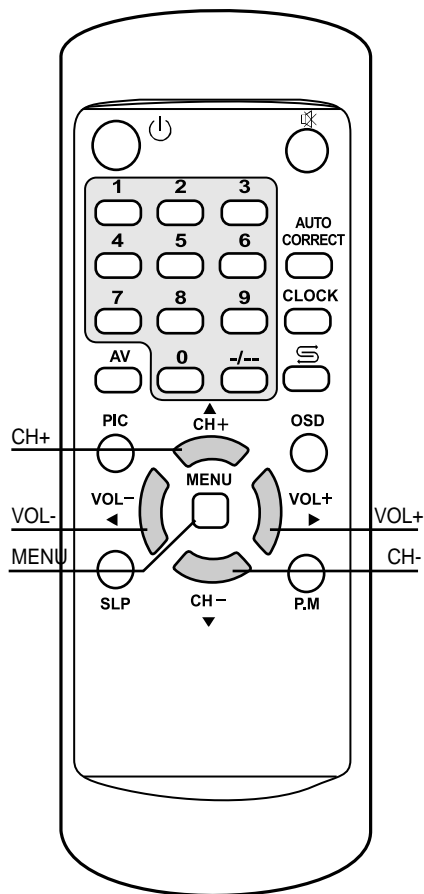
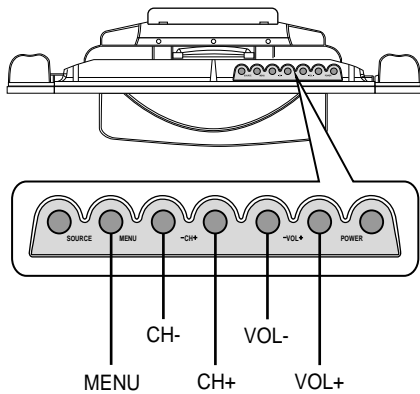

Picture adjustment

- 1 Press **MENU** button to access the menu.
- 2 Press **CH+/-** buttons to select the item.
- 3 Press **VOL+/-** buttons to adjust the item.

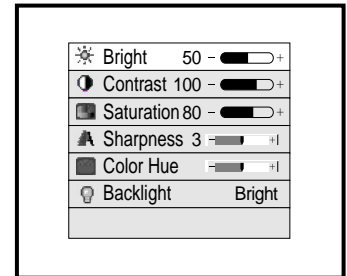

Item	Function	Remarks
Brightness	Adjusting the brightness	To adjust picture's bright and contrast in PC mode (does not affect picture in TV or AV mode).
Contrast	Adjusting the contrast	
Horizontal	Adjusting horizontal position	If VGA input signal is not standard, you can adjust these two items until proper picture position is obtained.
Vertical	Adjusting vertical position	
Phase	Adjusting phase	If the best picture can not be obtained after many times of auto correction, you can adjust these two items to obtain the best picture.
Frequency	Adjusting frequency	
Colour Temperature	Adjusting preset colour temperature	Colour temperature switch between User, 9300K, 7300K 6500K & 5000K
Backlight	Adjusting the backlight	You can select Soft, Nature and Bright.

Troubleshooting

Troubleshooting

Before calling service personnel, please check the following chart for a possible cause to the trouble you are experiencing.

Symptoms	Check the following items
Power is not turned on	Be sure the power cord is plugged in.
Poor colour, poor tint	Contrast, colour, tint are not correctly adjusted
Spots appear on the screen	Possible interferences of automobiles, motorcycle, trolley bus, neon lamps, etc.
Stripes appear on the screen	Possible interference of electronic interference from another TV set, a computer, an electronics game machine, a broadcast station, etc.
Double images or "ghosts"	This may be caused by reflections from nearby mountains or buildings. Check the antenna direction.
Snowy picture	It is possible that the aerial "lead-in" is damaged or comes off. Check the antenna direction.
Remote controller does not work	The batteries may be worn out. The batteries may be installed with their polarity reversed.

Power Supply:	~240V, 50Hz
Power Consumption:	65W
Dimensions (mm):	730 x 290 x 560
Weight (kg):	15
CRT:	51cm

TV system & channel range

System	VHF	UHF	CATV
PAL-B/G	2-12	21-69	X~Z+2, S1~S41

Colour System:	PAL, NTSC (AV)
Sound output:	2W x 2

Accessories:	Owner's manual x 1
	Power cord x 1
	VGA cable x 1
	Remote control x 1

⚠ Design and specifications are subject to change without notice.

PALSONIC CORPORATION PTY LTD
1 JOYNTON AVENUE
WATERLOO NSW 2017 AUSTRALIA
TEL: (02) 9313 7111
FAX: (02) 9313 7555
www.palsonic.com.au

**PALSONIC CUSTOMER SERVICE
TELEPHONE
AUSTRALIA: 1300 657 888**