

OWNER'S MANUAL

Palsonic

81CM CORDLESS REMOTE LCD TELEVISION & MONITOR

MODEL: TFTV815S



N111

**PALSONIC CORPORATION PTY LTD
1 JOYNTON AVENUE
WATERLOO NSW 2017 AUSTRALIA
TEL: (02) 9313 7111
FAX: (02) 9313 7555
www.palsonic.com.au**

**PALSONIC CUSTOMER SERVICE
TELEPHONE
AUSTRALIA: 1300 657 888**

Table of Contents

Important Safety Precautions	1
Preparations	3
Using the Remote Control	3
Batteries for the Remote Control	3
Antenna Connection	4
Power Connection	4
Identification of Controls	5
Main Unit	5
Remote Control	7
Connections	9
Cautions before Connecting	9
Connect a Decoder	9
Connect a VCR	10
Connect a AV or S-Video Inputs	11
Connect a DVD Player or Home Cinema System	12
Connect a Product to HDMI	13
Connect a PC	13
Turning the Unit On and Off	14
Turning the Unit On or Off.....	14
Viewing the Menus and Displays	14
Viewing TV Programs	15
Select a Region	15
Setting APS Function On and Off	15
Auto Search	15
Manual Fine Tuning	15
Manual Search	16
Skipping Channel	16
Editing Channels	16
Setting Favourite Channel	17
Editing Program Name	17
Locking TV Channels	18
Locking or Unlocking TV Channels	18
Setting Locking Function On or Off	18
Changing Password	18
Basic Operations	19
Changing Channels	19
Adjusting the Volume	19
Muting the Sound	19
Select Input Source Signal	19
Setting Picture	20
Using the Preset Picture Mode	20
Customising the Picture	20
Reducing Picture Noise	20
Freezing Picture	20

Table of Contents (continued)

Selecting the Preset Colour Temperature	21
Setting the APL Function On or Off	21
Setting Sound	22
Adjusting the Volume	22
Adjusting the Sound Balance	22
Adjusting the Headphone Volume	22
Adjusting Equaliser	22
Stereo/Bilingual Selection	23
Setting System	24
Setting Colour System	24
Setting Sound System	24
Changing Screen Aspect Ratio	24
Setting Menu Language	24
Setting Menu Background	25
Setting WSS	25
Setting Blue Screen	25
Setting Sleep Timer	25
Setting Timer	25
Setting On Program and On Volume	25
Changing Screen Layout	26
Selecting Screen Layout	26
PIP Operations	27
Viewing the Picture-in-Picture	27
Using PIP-POS button	27
Using ACT.WIN Button	27
Swap the Contents of the PIP Image and Main Image	27
Adjustment in D-Sub/DVI Mode	28
Adjusting Image Horizontal Size	28
Changing the Position of Image	28
Adjusting Phase	28
Adjusting the Screen Automatically	28
Loading Default Values	28
Teletext	29
What is Teletext	29
Turning On and Off Teletext	29
Button Functions	29
Troubleshooting	30
Care and Maintenance	31
Specifications	32

Important Safety Precautions

Electrical energy can perform many useful functions, but it can also cause personal injuries and property damage if improperly handled. This product has been engineered and manufactured with the highest priority on safety. But **IMPROPER USE CAN RESULT IN POTENTIAL ELECTRICAL SHOCK OR FIRE HAZARD**. In order to prevent potential danger, please observe the following instructions when installing, operating and cleaning the product. To ensure your safety and prolong the service life of your LCD TV product, please read the following precautions carefully before using the product.

- 1. Read these instructions** --- All operating instructions must be read and understood before the product is operated.
- 2. Keep these instructions** --- These safety and operating instructions must be kept in a safe place for future reference.
- 3. Head all warnings** --- All warnings on the product and in the instructions must be observed closely.
- 4. Follow all instructions** --- All operating instructions must be followed.
- 5. Attachments** --- Only use attachments/accessories specified by the manufacturer. Do not use attachments not recommended by the manufacturer. Use of improper attachments can result in accidents,
- 6. Power source** --- This product is intended to be supplied by a listed power supply indicated on the marking label. If you are not sure of the type of power supply to your home, consult your product dealer or local power company. For added protection for this product during a lightning storm, or when it is left unattended and unused for long periods of time, unplug it from the wall outlet and disconnect the cable system.
- 7. Power cord protection** --- Protect the power cord from being walked on or pinched particularly at plugs, convenience receptacles, and the point where they exit from the apparatus.
- 8. Overloading** --- Do not overload wall outlets, extension cords, or convenience receptacles on other equipment as this can result in a risk of fire or electric shock.
- 9. Entering of objects and liquids** --- Never insert an object into the product through vents or openings. High voltage flows in the product, and inserting an object can cause electric shock and/or short internal parts. For the same reason, do not spill water or liquid on the product.
- 10. Servicing** --- Refer all servicing to qualified service personnel. Servicing is required when the apparatus has been damaged in anyway, such as power-supply cord or plug is damaged, liquid has been spilled or objects have fallen into the apparatus, the apparatus has been exposed to rain or moisture, does not operate normally, or has been dropped.
- 11. Damage requiring service** --- If any of the following conditions occurs, unplug the power cord from the AC outlet, and request a qualified service person to perform repairs.
 - a. When the power cord or plug is damaged.
 - b. When a liquid is spilled on the product or when objects have fallen into the product.
 - c. When the product has been exposed to rain or water.
 - d. When the product does not operate properly as described in the operating instructions.Do not touch the controls other than those described in the operating instructions. Improper adjustment of controls not described in the instructions can cause damage, which often requires extensive adjustment work by a qualified technician.
 - e. If the product has been dropped or the cabinet has been damaged in anyway.
 - f. When the product displays an abnormal condition or exhibits a distinct change in performance. Any noticeable abnormality in the product indicates that the product needs servicing.
- 12. Replacement parts** --- In case the product needs replacement parts, make sure that the service person uses replacement parts specified by the manufacturer, or those with the same characteristics and performance as the original parts. Use of unauthorised parts can result in fire, electric shock and/or other danger.
- 13. Safety checks** --- Upon completion of service or repair work, request the service technician to perform safety checks to ensure that the product is in proper operating condition.
- 14. Wall or ceiling mounting** --- When mounting the product on a wall or ceiling, be sure to install the product according to the method recommended by the manufacturer. This is a safety feature.

Important Safety Precautions (continued)

15. Stand --- Use only with the cart, stand, tripod, bracket, or table specified by the manufacturer, or sold with the apparatus. Do not place the product on an unstable trolley, stand, tripod or table. Placing the product on an unstable base can cause the product to fall, resulting in serious personal injuries as well as damage to the product. When mounting the product on a wall, be sure to follow the manufacturer's instructions. Use only the mounting hardware recommended by the manufacturer.

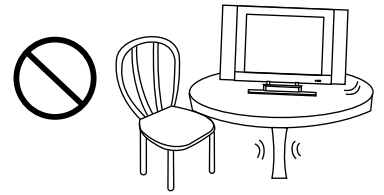

16. Careful move --- When a cart is used, use caution when moving the cart/apparatus combination to avoid injury from tip-over. Sudden stops, excessive force and uneven floor surfaces can cause the product to fall from the trolley.



17. Lightning --- Unplug this apparatus during lightning storms or when unused for long periods of time. For added protection for this television equipment during a lightning storm, or when it is left unattended and unused for long periods of time, unplug it from the wall outlet and disconnect the antenna. This will prevent damage to the equipment due to lightning and power-line surges.

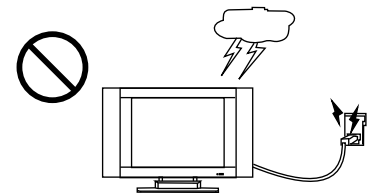

18. Do not use this apparatus near water --- for example, near a bathtub, washbowl, kitchen sink, or laundry tub, in a wet basement, or near a swimming pool, and the like. Do not use immediately after moving from a low temperature to high temperature environment, as this causes condensation, which may result in fire, electric shock, or other hazards.



19. Clean only with dry cloth --- Unplug this product from the wall outlet before cleaning. Do not use liquid cleaners or aerosol cleaners. Use a damp cloth for cleaning.

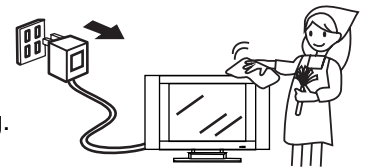

20. Ventilation --- Do not block any ventilation openings. Install in accordance with the manufacturer instructions. The vents and other openings in the cabinet are designed for ventilation. Do not cover or block these vents and openings since insufficient ventilation can cause overheating and/or shorten the life of the product. Do not place the product on a bed, sofa, rug or other similar surface, since they can block ventilation openings. This product is not designed for built-in installation; do not place the product in an enclosed place such as a bookcase or rack, unless proper ventilation is provided or the manufacturer's instructions are followed.

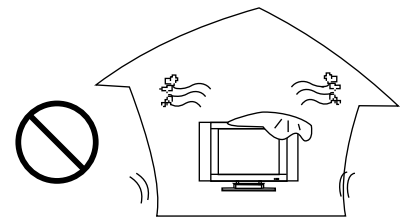

21. Heat sources --- Do not install near any heat sources such as radiators, heat registers, stoves, or other apparatus (including amplifiers) that produce heat.

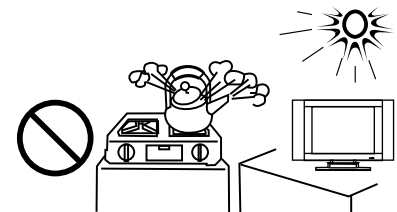

22. Panel protection --- The LCD panel used in this product is made of glass. Therefore, it can break when the product is dropped or impacted upon by other objects. Be careful not to be injured by broken glass pieces in case the LCD panel breaks.

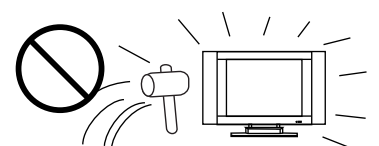

23. Pixel defect --- The LCD panel is a very high technology product, giving you finely detailed pictures. Occasionally, a few non-active pixels may appear on the screen as a fixed point of blue, green or red. Please note that this does not affect the performance of your product.

Preparations

Using the Remote Control

- Use the remote control by pointing it towards the remote sensor window of the set. Objects between the remote control and sensor window may prevent proper operation.

Note: the illustration is for your reference only, the remote sensor may locate differently with different model.

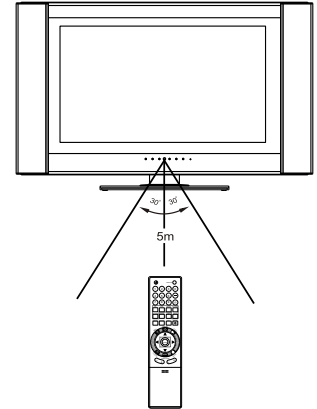

Cautions regarding use of remote control

- Do not expose the remote control to shock. In addition, do not expose the remote control to liquids, and do not place in an area with high humidity.
- Do not install or place the remote control under direct sunlight. The heat may cause deformation of the unit.
- The remote control may not work properly if the remote sensor window of the main unit is under direct sunlight or strong lighting. In such a case, change the angle of the lighting or LCD TV set, or operate the remote control closer to the remote sensor window.

Batteries for the Remote Control

If the remote control fails to operate the LCD TV functions, replace the batteries in the remote control.

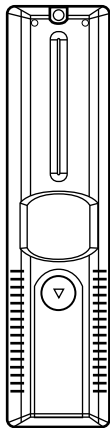

- 1 Open the battery cover.
- 2 Insert two size-AAA batteries.
 - (Place the batteries with their terminals corresponding to the (+) and (-) indications in the battery compartment.)
- 3 Replace the cover and slide in reverse until the lock snaps.

Precautions on battery use

Improper use of batteries can result in a leakage of chemicals and/or explosion. Be sure to follow the instructions below.

- Place batteries with their terminals corresponding to the (+) and (-) indications.
- Different types of batteries have different characteristics. Do not mix batteries of different types.
- Do not mix old and new batteries. Mixing old and new batteries can shorten the life of new batteries and/or cause old batteries to leak chemicals.
- Remove batteries as soon as they are non-operable. Chemicals that leak from batteries can cause a rash. If chemical leakage is found, wipe with a cloth.
- The batteries supplied with the product may have a shorter life expectancy due to storage conditions.
- If the remote control is not used for an extended period of time, remove the batteries from the remote control.

Preparations (continued)

Antenna Connection

INSTALL the unit in a room where direct light will not fall upon the screen. Total darkness or a reflection on the picture screen may cause eyestrain. Soft and indirect lighting is recommended for comfortable viewing.

Optimum reception of colour requires a good signal and will generally mean that an outdoor aerial must be used. The exact type and position of the aerial will depend upon your particular area.

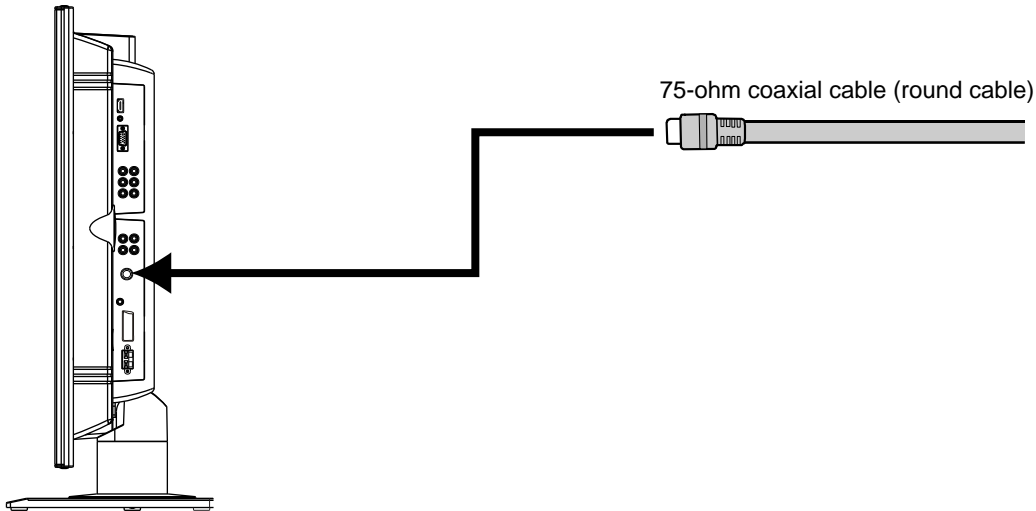

Note:

It is recommended that the 75-ohm coaxial cable be used to eliminate interference and noise which may occur due to radio wave conditions.

The aerial cable should not be bundled with the power cord and the like.

Power Connection

Insert the AC Power plug into a conveniently located AC Outlet

Note:

- *This product should be operated only from the type of power source indicated on the marking label.*
- *Always unplug the AC cord from power outlet when not using for a long period of time.*

Identification of Controls

Main Unit

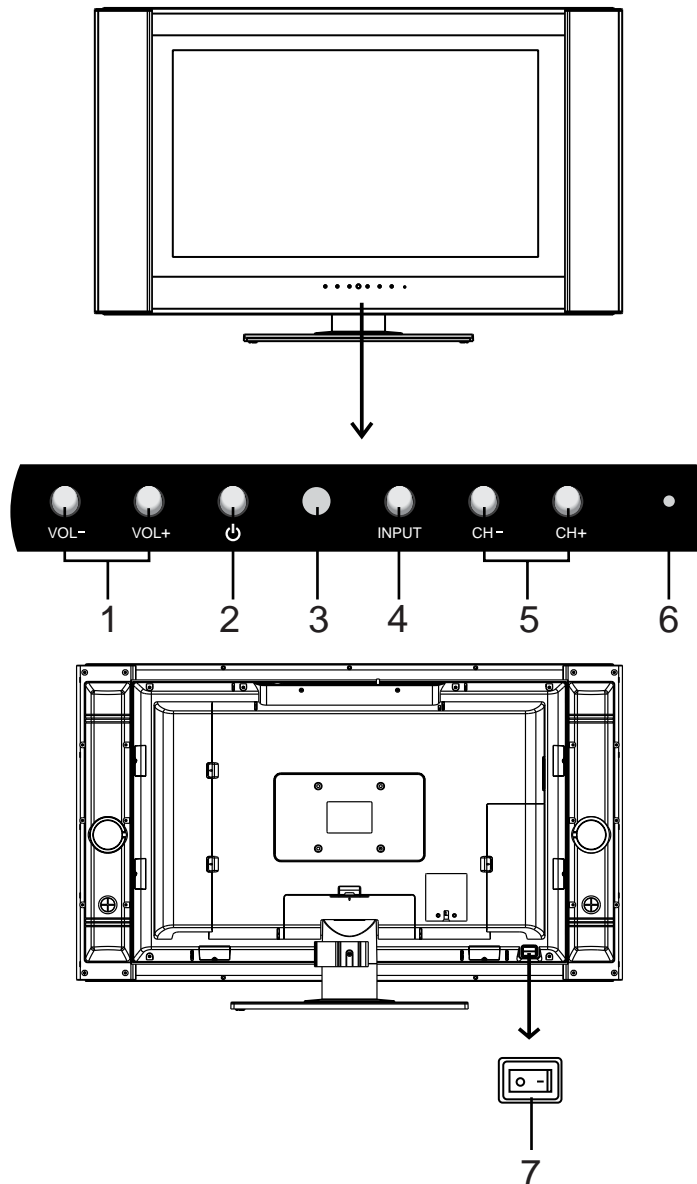

1. VOL+/-

Press the **VOL+** or **VOL-** button to directly increase or decrease the sound volume level;

2. MENU

Press this button to access the Menu main page.

3. Remote Sensor

4. SOURCE

To access signal source select menu

5. CH+/-

Press these two buttons to directly change the TV channel;

6. Power Indicator

7. Power Switch

Note:

Functions of **VOL+/-**, **CH+/-**, **MENU** and **SOURCE** are also provided to the remote control. This operation manual provides a description based on operating functions with the remote control.

OSD means On Screen Display.

Identification of Controls (continued)

Main Unit

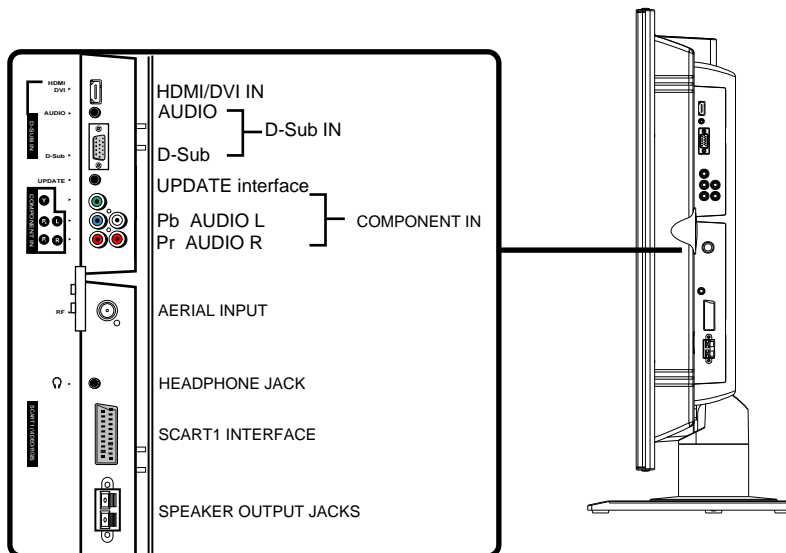
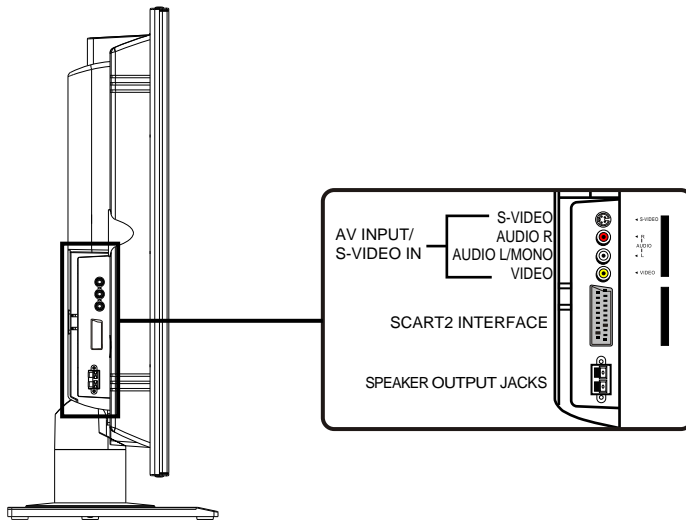

1. AV inputs (Video, Audio L/MONO, R) / S-Video input

Receive video/audio signals from external sources such as VCR or DVD player.

Receive a S-Video signal from external source such as VCR or DVD player.

2. 21-pin Euro-SCART1 (VIDEO/S-VIDEO) interface

3. HDMI/DVI interface

4. D-Sub input/Audio in

Connect to the D-Sub/audio output sockets on your PC.

5. UPDATE interface

For service use only. The user cannot operate the unit through the **UPDATE** interface.

6. Component inputs (Y, Pb, Pr, Audio L, R)

Connect to the component and audio output sockets of a DVD player or Set-Top Box.

7. Aerial input

Allows you to connect cable or outdoor aerial

8. Headphone jack

9. 21-pin Euro-SCART1 (VIDEO/RGB) interface

10. Speaker output jacks

Connect the speaker audio cable to the speaker output jacks on the unit matching the "+" and "-" ends of the cable with colour.

Identification of Controls (continued)

Remote Control

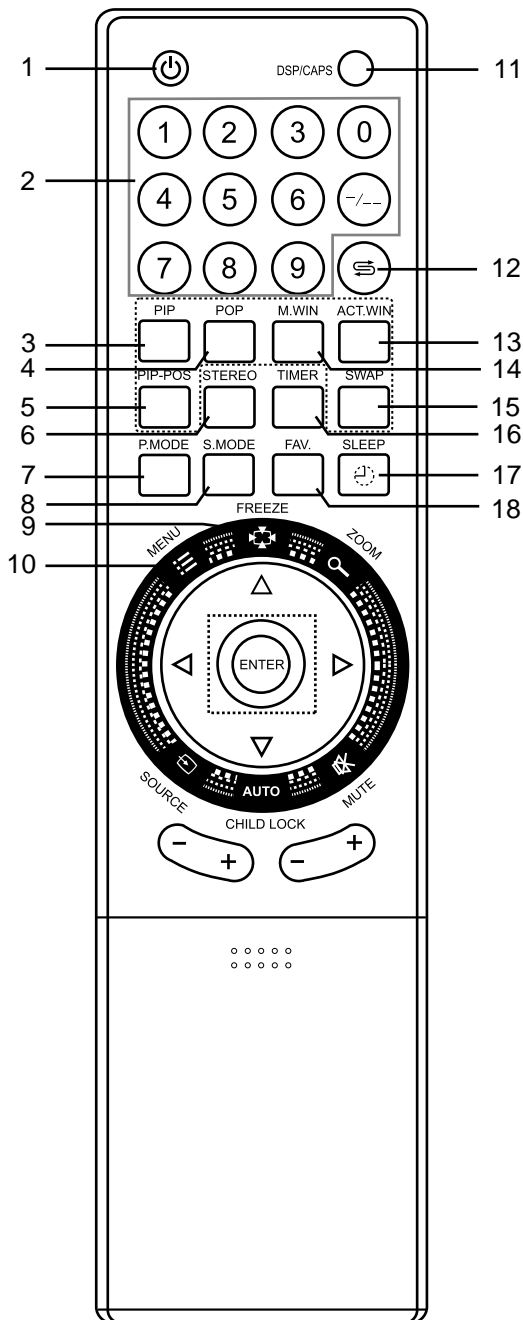

1. POWER Turn the unit on or standby
2. 0~9 digit buttons, -/-- button
0~9: direct channel select;
To input characters when editing channel label
-/-- button: two digit/three digit channel number selector
3. PIP
To activate picture-in-picture
4. POP
activate picture-out-picture
5. PIP-POS
To select PIP frame position
6. STEREO
To select stereo, mono or bilingual
7. P.MODE
To quickly select picture mode
Red button (teletext)
8. S.MODE
To quickly select sound mode
Green button (teletext)
9. FREEZE
To freeze current picture
10. MENU
To access the MENU main page
In Menu operation, press this button to return to a higher level menu
11. DSP/CAPS
To display current channel status
To switch between uppercase and lowercase input mode when editing channel label.
12. RETURN To quickly jump between current channel and last selected channel.
To switch to previous source
13. ACT.WIN
To select main picture frame or PIP frame when viewing picture-in-picture
14. M.WIN
To select to view multi-window mode
15. SWAP/SORT
In full screen of TV program, press this button to access channel editing mode
When viewing PIP TV program, press this button to exchange the Contents of the PIP Image and Main Image
16. TIMER
To set current time, turn-off timer or turn-on timer
17. SLEEP
To set sleep timer
Blue button (teletext)
18. FAV.
To cycle among all favourite channels
Yellow button (teletext)

Identification of Controls (continued)

Remote Control

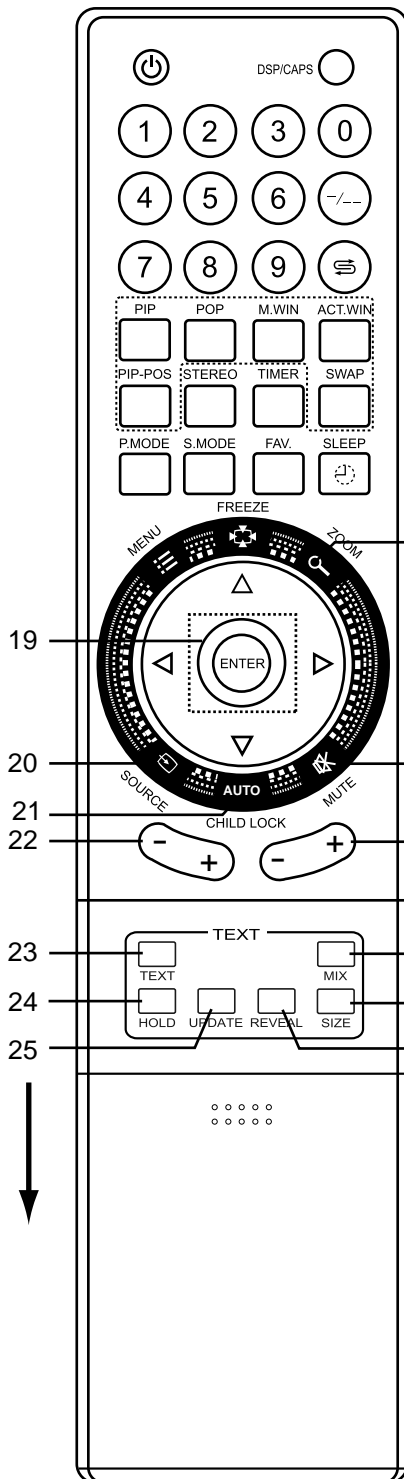

- 19. ENTER, ENTER (Up/Down), ENTER (Left/Right)
 ENTER: To confirm your operation or setting or access submenu;
 ENTER (Up/Down) To move upward or downward in menu operation;
 ENTER (Left/Right) To move left or right in menu operation;
 To adjust selected menu item in menu operation
- 20. SOURCE
 To access source select menu
- 21. AUTO/CHILD LOCK
 To rectify the picture automatically in VGA model lock or unlock channels in TV mode
- 22. CHANNEL +/-
 Use to switch channels;
- 23. TEXT
 To enter/exit teletext mode (Teletext)
- 24. HOLD
 To hold the current teletext page temporarily (Teletext)
- 25. UPDATE
 To view update teletext page (Teletext)
- 26. ZOOM
 To select Screen Aspect Ratio
 This button doesn't work under [POP 4:3], [POP Full], [4 Windows], [9 Windows]
- 27. MUTE
 Sound mute
- 28. VOLUME +/-
 Use to adjust volume
- 29. MIX
 To superimpose text on a TV picture (Teletext)
- 30. SIZE
 To expand top half or bottom half page of current screen (Teletext)
- 31. REVEAL
 To display hidden information such as solutions to riddles and puzzles. (Teletext)

Connections

Cautions before connecting

- Carefully check the terminals for position and type before making any connections.
- The illustration of the external equipment may be different depending on your model.
- Loose connectors can result in image or colour problems. Make sure that all connectors are securely inserted into their terminals.
- Refer to the operating manual of the external device as well.
- When connecting an external device, turn the power off on the panel to avoid any issues.

Connect a Decoder

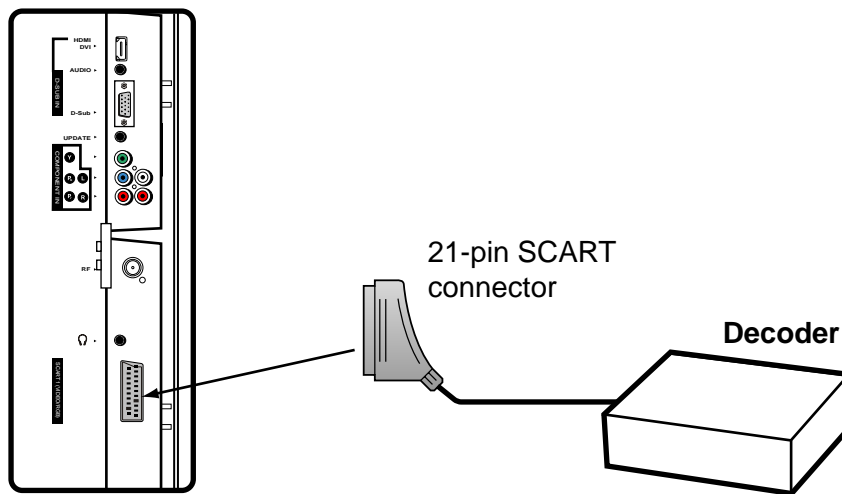

How to connect:

Connect the SCART Cable between the unit and the Decoder.

To watch Decoder

1. Turn on your LCD TV, press **SOURCE**  button on the remote control.
2. Push **ENTER** (Up/Down) to select **SCART 1** and press **ENTER** to confirm.
3. Turn on your Decoder.

Select Main Source
1. TV
2. Video
3. S-Video
4. SCART 1
5. SCART 2 AV
6. SCART 2 Y/C
7. YPbPr
8. D-Sub
9. HDMI

Note:

1. The unit receives **CVBS (VIDEO)** signal and **RGB** signal from **SCART1** interface and is able to identify the signal format automatically. The unit chooses the **RGB** signal prior to the **CVBS (VIDEO)** signal.
2. To connect to external devices with AV terminals, you may use 21-pin Scart Converter to connect to SCART interface on the unit, and the unit receives **CVBS (VIDEO)** signal only.

Connections (continued)

Connect a VCR

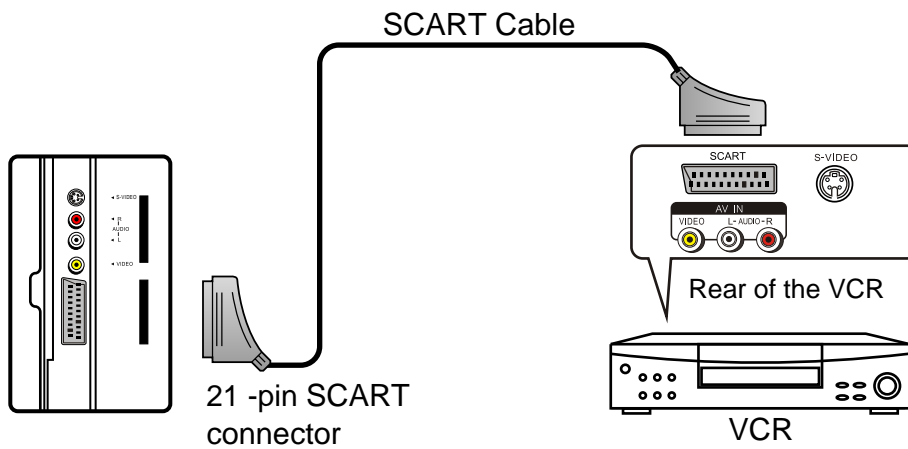

How to connect:

Connect the SCART Cable between the unit and the VCR.

To play VCR

1. Turn on your LCD TV, press **SOURCE**  button on the remote control.
2. Push **ENTER** (Up/Down) to select **Scart2 AV** and press **ENTER** to confirm.
3. Turn on your VCR, insert a videotape and press the Play button.

Select Main Source

1. TV
2. Video
3. S-Video
4. SCART 1
5. SCART 2 AV
6. SCART 2 Y/C
7. YPbPr
8. D-Sub
9. HDMI

Note:

The unit receives **CVBS (VIDEO)** signal and **Y/C (S-VIDEO)** signal from **SCART2** interface.

When receiving **Y/C** signal, you need to select **Scart 2 Y/C** instead of **Scart 2 AV** in the source select menu.

Therefore, if you find that the colour is not properly displayed, please try to select **Scart 2 Y/C**.

To connect to external devices with AV terminals, you may use 2 I-pin Scart Converter to connect to SCART interface on the unit, then please select **Scart 2 AV** and the unit receives **CVBS (VIDEO)** signal only.

Connections (continued)

Connect AVI or S-Video Inputs

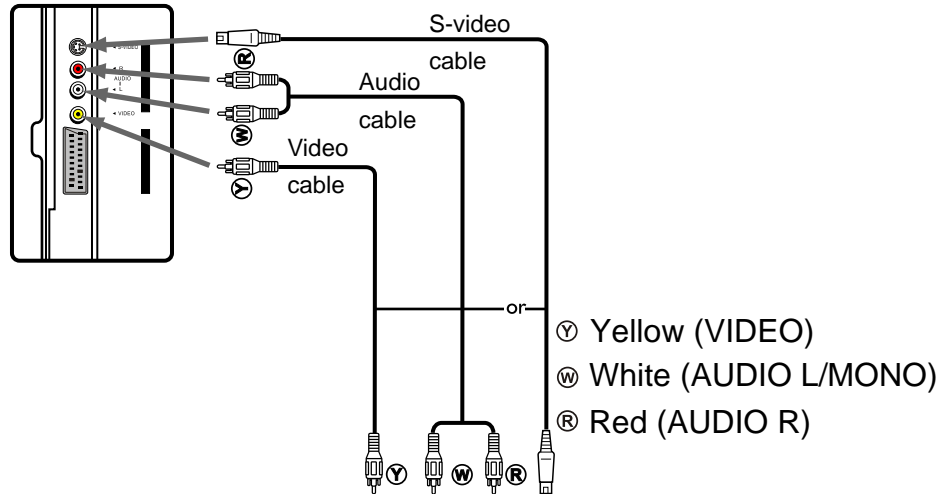

Examples of external devices that can be connected



VCR

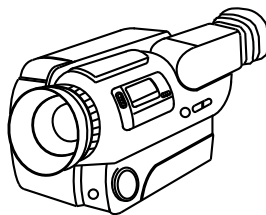

Video Camera

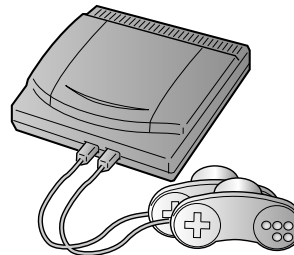

Home video game system

The unit provides Audio/Video inputs for you to connect external devices such as VCR, Video Camera or Home video game system.

How to connect:

Connect the Audio/Video cables between the Audio (L/R)/Video jacks on the unit and external devices.

To view signal from AV/S-VIDEO inputs

1. Turn on your LCD TV, press **SOURCE** button on the remote control.
2. Press **ENTER** (Up/Down) to select **Video** or **S-Video** and press **ENTER** to confirm.
3. Turn on the external device and play it.

Select Main Source

1. TV
2. Video
3. S-Video
4. SCART 1
5. SCART 2 AV
6. SCART 2 Y/C
7. YPbPr
8. D-Sub
9. HDMI

Note:

For better video, you can use the **S-Video** terminal if your source supports it. If you are going to use **S-Video** terminal, please select **S-Video** instead of **Video** in source menu

The **Video** input terminal on the **AV IN** and the **S-Video** input terminal share the same **Audio** input terminals.

The **S-Video** is prior to **Video** terminal when they are connected at the same time. To view the picture from the **Video** terminal, disconnect any plug from the **S-Video** terminal.

Connections (continued)

Connect a DVD Player or Home Cinema System

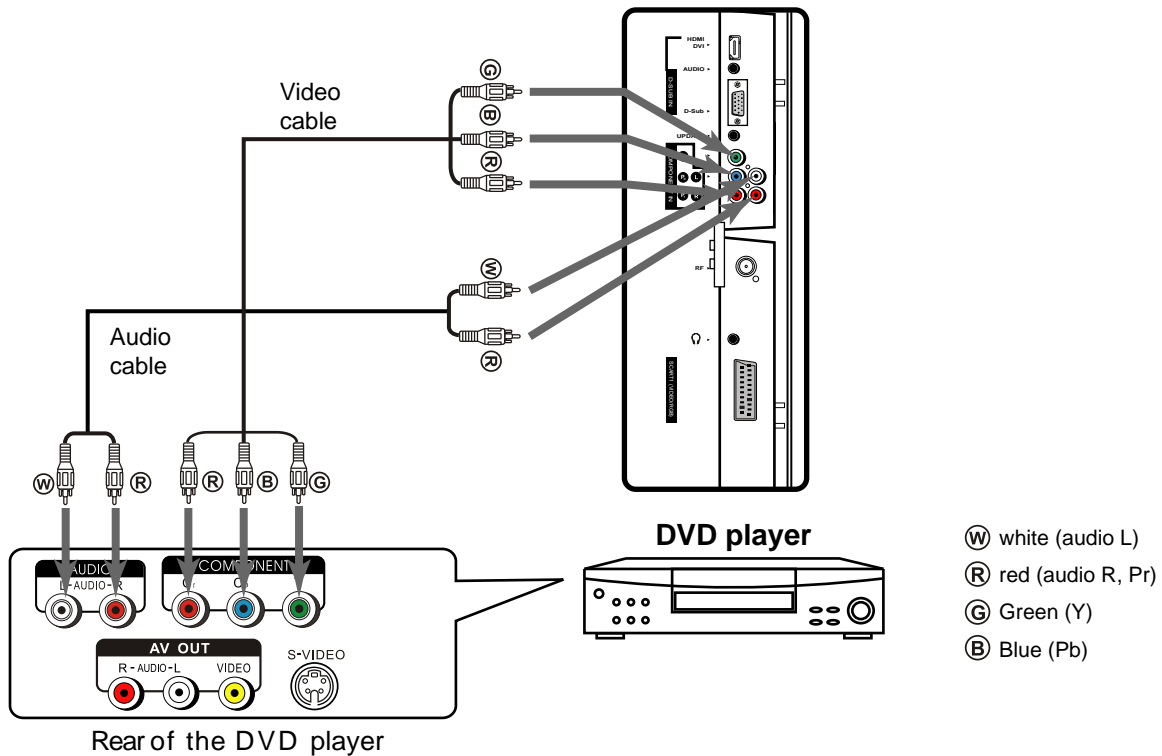

How to connect a DVD Player or Home Cinema System using Component Video Connections:

Connect the Video cable between the Y, Cb, Cr input jacks on the unit and Cb, Cr output jacks on the DVD player. Connect the Audio cable between the AUDIO input jack on the unit and AUDIO output jacks on the DVD player.

To play DVD

1. Turn on your LCD TV, press **SOURCE**  button on the remote control.
2. Press **ENTER** (Up/Down) to select **YPbPr**.
3. Press **ENTER** to confirm.
4. Turn on your DVD player, insert a DVD disc and press the Play button.

Select Main Source

1. TV
2. Video
3. S-Video
4. SCART 1
5. SCART 2 AV
6. SCART 2 Y/C
7. YPbPr
8. D-Sub
9. HDMI

Note:

The Y, Pb, Pr outputs on your DVD player are sometimes labelled Y, Cb, Cr or Y, B-Y, R-Y. If so, connect the cables to like colours.

Connections (continued)

Connect a product to HDMI

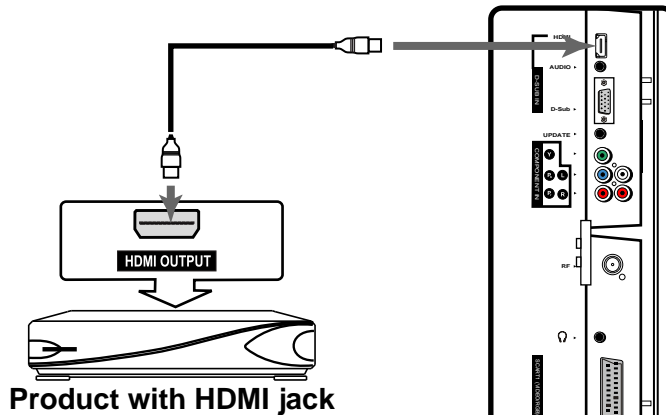

How to connect:

Connect the HDMI cable between the HDMI input jacks on the unit and HDMI output jacks on the product.

Note:

The HDMI Sources are compatible with DVI displays through the use of a passive cable converter. So you may connect product with DVI output jack to the unit.

Connect a passive cable converter between the HDMI input jack on the unit and DVI output jack on the product.

Connect an Audio cable between the AUDIO output on your product and AUDIO input jack of **D-Sub IN** on the unit.

To Watch your Product

1. Turn on your LCD TV, press **SOURCE** button on the remote control.
2. Push **ENTER** (Up/Down) to select **HDMI**.
3. Press **ENTER** to confirm.
4. Turn on your product.

Select Main Source

1. TV
2. Video
3. S-Video
4. SCART 1
5. SCART 2 AV
6. SCART 2 Y/C
7. YPbPr
8. D-Sub
9. **HDMI**

Connect a PC

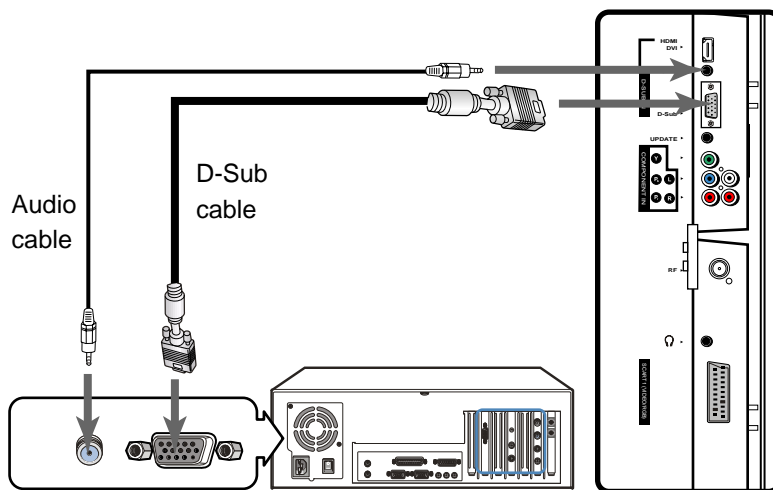

How to connect:

Connect a D-Sub cable between the S-Sub interface on the PC the D-Sub interface on the unit.

Connect an Audio cable between the AUDIO output on the PC and AUDIO input jack on the unit.

To Watch the PC screen

1. Turn on your LCD TV, press **SOURCE** button on the remote control.
2. Press **ENTER** (Up/Down) to select **D-Sub** (D-Sub).
3. Press **ENTER** to confirm.
4. Turn on your PC and check for PC system requirements.
5. Adjust the PC screen.

Select Main Source

1. TV
2. Video
3. S-Video
4. SCART 1
5. SCART 2 AV
6. SCART 2 Y/C
7. YPbPr
8. **D-Sub**
9. HDMI

Turning the Unit On and Off

Turning the Unit On and Off

Turning On

Insert the power cord into the wall outlet.

Press the **Power Switch** on the unit, then press the **Power**  button on the remote control.

The unit will be turned on and you will be ready to use its features.

Turning Off

With the power on, Press the **Power**  button on the remote control to turn off the unit, and put the unit in standby mode.

To cut off the power completely, press the **Power Switch**.

Viewing the Menus and Displays

Your LCD TV has a simple, easy-to-use menu system that appears on the screen. This system makes it convenient and fast to use features on the unit.

Viewing the Menus

- 1 With the power on, press the **MENU** button on the remote control. The main menu appears on the screen.
- 2 Push the **ENTER** (Up/Down) to select menu page. Press **ENTER** to access the menu page.
- 3 Push **ENTER** (Up/Down) to select item. Push **ENTER** (Left/Right) to adjust value or setting of each item. Press **MENU** to exit menu system.
On-screen menu will disappear from the screen automatically after some seconds, or you can press the **MENU** button repeatedly to exit the menu system.

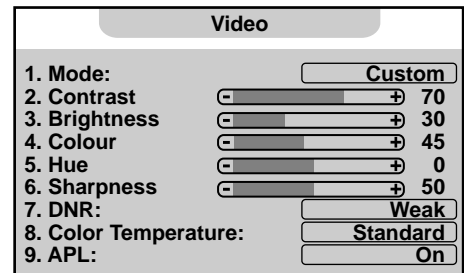

Note:

- In Menu operations, you may push **ENTER** (Up/Down) to select item or just press the relevant number button according to the number indicated on the left of the menu item.
- To clearly introduce the menu operations, this operation manual provides a description based on operation with the remote control.

Displaying Status Information

The unit displays current status information (e.g channel number, channel name, channel locking status, colour and sound system or stereo mode) by pressing the **DSP/CAPS** button.

1. Information for main picture frame
2. Current channel name
3. Favourite channel icon
4. Locked status icon
5. Current channel number
6. Sound system
7. Stereo mode
8. NICAM status
9. Colour system

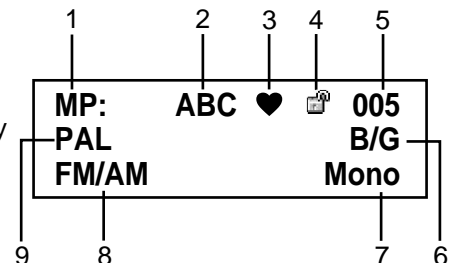

Note:

Some of the above items are not always displayed on the screen and they are subject to your settings.

Viewing TV Programs

Your LCD TV can memorise and store all of the available channels. After the available channels are memorised, use **CHANNEL+/-** to scan through the available stations.

Select a Region

Before you start automatic search, it is necessary to select a region firstly.

- 1 Press **MENU** to display the menu main page.
- 2 Push **ENTER** (Up/Down) repeatedly to display **Option** menu page.
- 3 Press **ENTER** to access.
- 4 Push **ENTER** (Down) repeatedly to select **Program Area** item.
- 5 Push **ENTER** (Left/Right) to select a proper region according to your area.
- 6 Press **MENU** repeatedly to exit.

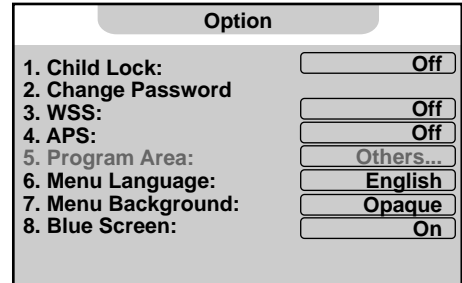

Setting APS Function On or Off

- 1 Repeat steps 1~3 in [**Select a Region**].
- 2 Push **ENTER** (Down) repeatedly to select the **APS** item.
- 3 Push **ENTER** (Left/Right) to select **On** or **Off**.
- 4 Press **MENU** repeatedly to exit.

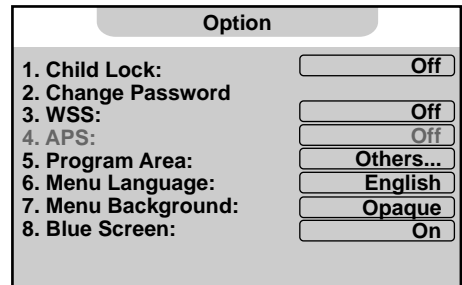

After auto searching, the channels will be ranged automatically according to VPS (Video Program System) information when this item is set to **On** in advance.

Auto Search

- 1 Press **MENU** to display the menu main page.
- 2 Push **ENTER** (Up/Down) repeatedly to display **Program** menu page.
- 3 Press **ENTER** to access.
- 4 Push **ENTER** (Down) repeatedly to select **Auto Search** item.
- 5 Press **ENTER** to start auto search.
The unit will begin memorising all of the available channels.

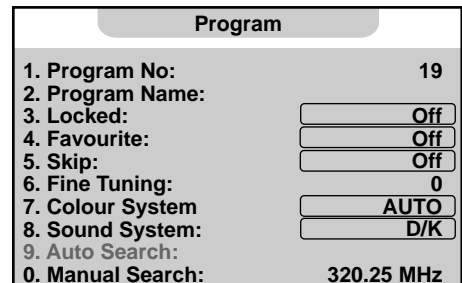

Note:

The process of auto search will be stopped if you press the **MENU** button

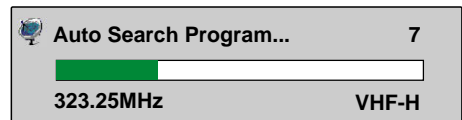

Manual Fine Tuning

- 1 Repeat steps 1~3 in [**Auto Search**].
- 2 Push **ENTER** (Down) repeatedly to select **Fine Tuning** item.
- 3 Push **ENTER** (Left/Right) to fine tune till the best possible picture and sound are obtained.
- 4 Press **MENU** to exit.

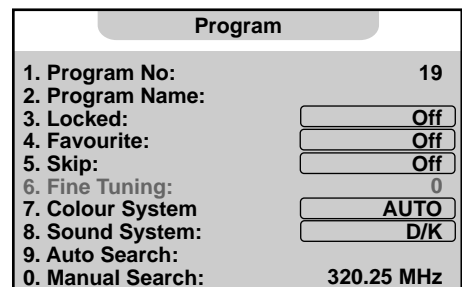

Viewing TV Programs (continued)

Manual Search.

Use Manual Search if desired channels can not be memorised or if you would like to store programs to specific channel numbers one by one.

- 1 Use **number buttons** to directly select a channel that you want to perform manual search.
- 2 Press **MENU** to display the menu main page.
- 3 Push **ENTER** (Up/Down) repeatedly to display **Program** menu page.
- 4 Press **ENTER** to access.
- 5 Push **ENTER** (Down) repeatedly to select **Manual Search** item.
- 6 YOU may press **ENTER** to input a frequency or Push **ENTER** (Left/Right) to search program from current frequency.
 - ▶ To search program manually by inputting a frequency:
 1. Press **ENTER**, the unit allows you to input a frequency.
 2. Input the desired frequency by using **0~9 buttons**, then the unit locates to your frequency. If you want to exit, press **MENU** again.

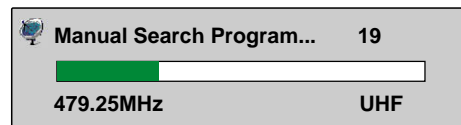
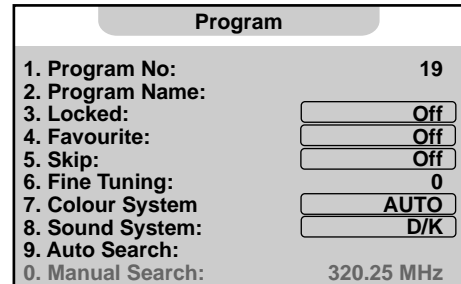

- ▶ To search program manually from current frequency:
 - Push **ENTER** (Right) the unit searches towards higher frequency;
 - Push **ENTER** (Left) the unit searches towards lower frequency;
 - The search stops when a program is found and this program will be stored in current channel.
 - During the process of manual search, you may control the searching direction by pushing **ENTER** (Left/Right).

Skipping Channel

- 1 Repeat steps 1~4 in **[Manual Search]**.
- 2 Push **ENTER** (Down) repeatedly to select **Skip** item.
- 3 Push **ENTER** (Left/Right) to select **On** or **Off**.
- 4 Press **MENU** repeatedly to exit.

When the item is set to on, the selected channel will be skipped.
 When the item is set to off, the selected channel will not be skipped.
 The skipped channels can not be selected by using the **CHANNEL+/-** buttons unless you use **number buttons** to input channel number directly.

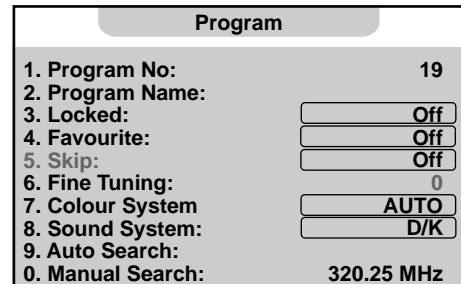

Editing Channels

The **edit channels** function is for you to arrange channel order as you wish.

When viewing single TV screen, press **SORT** to display **Channel Sort** menu. The current channel number appears in the [Program No.] item. Push **ENTER** (Down) to select **Sorted No.** item.

Push **ENTER** (Left/Right) to select a target channel which is to be exchanged with the current channel.

Push **ENTER** (Down) to highlight **OK** item.

Press **ENTER** to confirm exchanging contents in current channel and the target channel.

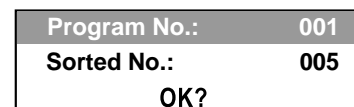

Viewing TV Program (continued)

Setting Favourite Channel

- 1 Press **MENU** to display the menu main page.
- 2 Push **ENTER** (Up/Down) repeatedly to display **Program** menu page.
- 3 Press **ENTER** to access.
Then the **Program No** item will be highlighted automatically.
- 4 Push **ENTER** (Left/Right) to select a channel that you want to set as your Favourite channel.
- 5 Push **ENTER** (Down) repeatedly to select **Favourite** item.
- 6 Push **ENTER** (Left/Right) to select **On** or **Off**.
- 7 Press **MENU** repeatedly to exit.

Program	
1. Program No:	19
2. Program Name:	
3. Locked:	<input type="text" value="Off"/>
4. Favourite:	<input type="text" value="Off"/>
5. Skip:	<input type="text" value="Off"/>
6. Fine Tuning:	<input type="text" value="0"/>
7. Colour System	<input type="text" value="AUTO"/>
8. Sound System:	<input type="text" value="D/K"/>
9. Auto Search:	
0. Manual Search:	320.25 MHz

When the item is set to on, the selected channel will be set as your favourite channel. You can repeat the above steps to set more favourite channels so that you can cycle among your favourite channels by pressing the **FAV.** button.

When you are viewing a favourite channel, a " ♥ " icon appears on the screen while pressing the **DSP/CAPS** button.

Editing Program Name

- 1 Repeat steps 1~4 in [**Manual Search**].
- 2 Push **ENTER** (Down) to select **Program Name** item.
- 3 Press **ENTER** to edit program name.

Push **ENTER** (Left/Right) to move cursor right or left.
Use **0~9 number buttons** to input characters.
Use **DSP/CAPS** to switch between lowercase and uppercase.
Push **ENTER** (Down) to delete a character.
After you finish inputting, you may use **ENTER** to confirm.
The maximum length of program name is 8 characters.

Program	
1. Program No:	19
2. Program Name:	ABC
3. Locked:	<input type="text" value="Off"/>
4. Favourite:	<input type="text" value="Off"/>
5. Skip:	<input type="text" value="Off"/>
6. Fine Tuning:	<input type="text" value="0"/>
7. Colour System	<input type="text" value="AUTO"/>
8. Sound System:	<input type="text" value="D/K"/>
9. Auto Search:	
0. Manual Search:	320.25 MHz

Button	Character List	Character List while pressing DSP/CAPS
0	0 * # ()	0 * # ()
1	1 _ - . !	1 _ - . !
2	2 a b c @	2 A B C @
3	3 d e f #	3 D E F #
4	4 g h i \$	4 G H I \$
5	5 j k l %	5 J K L %
6	6 m n o ^	6 M N O ^
7	7 p q r &	7 P Q R &
8	8 s t u v	8 S T U V
9	9 w x y z	9 W X Y Z

Locking TV Channels

Locking or Unlocking TV Channels

- 1 Repeat steps 1~3 in [Auto Search] to display **Program** menu page. Then the **Program No** item will be highlighted automatically.
- 2 Push **ENTER** (Left/Right) to select a channel that you want to lock or unlock.
- 3 Push **ENTER** (Down) repeatedly to select **Locked** item.
- 4 Push **ENTER** (Left/Right) to select **On** or **Off**.
- 5 Press **MENU** repeatedly to exit.
You can repeat the above steps to lock or unlock other channels.

Program	
1. Program No:	19
2. Program Name:	
3. Locked:	<input type="button" value="Off"/>
4. Favourite:	<input type="button" value="Off"/>
5. Skip:	<input type="button" value="Off"/>
6. Fine Tuning:	0
7. Colour System:	AUTO
8. Sound System:	<input type="button" value="D/K"/>
9. Auto Search:	
0. Manual Search:	320.25 MHz

Setting Locking Function On or Off

- 1 Repeat steps 1~3 in [Select a Region] to display **Option** menu page. Then the **Child Lock** item will be highlighted automatically.
- 2 Push **ENTER** (Left/Right) to select **On** or **Off**.
- 3 Press **MENU** repeatedly to exit.

Option	
1. Child Lock:	<input type="button" value="Off"/>
2. Change Password	
3. WSS:	<input type="button" value="Off"/>
4. APS:	<input type="button" value="Off"/>
5. Program Area:	<input type="button" value="Others..."/>
6. Menu Language:	<input type="button" value="English"/>
7. Menu Background	<input type="button" value="Opaque"/>
8. Blue Screen	<input type="button" value="On"/>

Note:

Only when [Child Lock] and [Locked] items are set to On at the same time that the locking TV channels function becomes effective.

When you select a locked channel, a "🔒" icon appears and the screen is blank. In this situation, if you still want to view the locked channel, you may follow these steps to unlock:

1. Press **CHILD LOCK** to display password input page.
2. Enter the password. The default password is "**000000**".

Once the correct password is inputted, the unit allows you to view all locked channels.

If the [Child Lock] item is set to [On], the unit asks you to input password if you want to access the [Program] menu page.

If you set the [Child Lock] item to [On], next time if you want to set the [Child Lock] item to [Off], the unit asks you to input password.

Changing Password

- 1 Repeat steps 1~3 in [Select a Region].
- 2 Push **ENTER** (Down) to select **Change Password** item.
- 3 Press **ENTER** to confirm.
- 4 Input the old password.
- 5 Input the new password.
- 6 Input the new password again and then the password has been changed successfully.

Option	
1. Child Lock:	<input type="button" value="Off"/>
2. Change Password	
3. WSS:	<input type="button" value="Off"/>
4. APS:	<input type="button" value="Off"/>
5. Program Area:	<input type="button" value="Others..."/>
6. Menu Language:	<input type="button" value="English"/>
7. Menu Background:	<input type="button" value="Opaque"/>
8. Blue Screen:	<input type="button" value="On"/>

Be sure to write down your password and retain it for future use. If you forget the password, the unit provides a master password as "**962326**" for you to access the locked channels or change password. Please **DO NOT** let the children know the master password.

Basic Operation

Changing Channels

Using the Channel Buttons (CHANNEL +/-)

Press the **CHANNEL +/-** to change channels.

When you press the **CHANNEL +/-**, the unit changes channels in sequence. You will see all the channels that the unit has memorised.

You will not see channels that were skipped.

Direct Accessing Channels

Press the number buttons to go directly to a channel.

To select a one-digit channel:

Input the channel number by using the **0-9 number buttons** directly.

To select a two-digit channel:

Press **--** to display **"-"** and input the channel number by using the **0-9 number buttons**.

To select a three-digit channel:

Press **---** to display **"- -"** and input the channel number by using the **0-9 number buttons**.

Note:

When you use the number buttons, You may directly select channels that were skipped.

Using the RETURN button

Press this button to switch between the current channel and the previous channel.

Adjusting the Volume

Using the volume buttons (VOLUME +/-)

Press the **VOLUME +** or **VOLUME -** to increase or decrease the volume.

Muting the Sound

Using the MUTE button

At any time, you can temporarily turn off the sound using the **MUTE ** button.

1 Press the **MUTE ** button and the sound turns off.

2 To turn mute off, press the **MUTE ** button again.

Select Input Source Signal

1 Press **SOURCE ** to access source select menu.

2 Press **ENTER** (Up/Down) to select a desired signal source.

You may directly press the relevant number button to select a desired signal source.

3 Press **ENTER** to confirm.

TV ----- select TV signal.

Video ----- select signal from Video terminal.

S-Video ----- select signal from S-Video terminal.

SCART1 ----- select signal from 21-PIN SCART 1 interface.

SCART2 AV ----- select signal from 21-PIN SCART 2 interface.

SCART2 Y/C ----- select SCART 2 YC when viewing Y/C signal from 21-PIN SCART 2 interface.

YPbPr ----- select signal from YPbPr or YCbCr terminals.

D-Sub ----- select signal from D-Sub (1 5-pin D-sub) terminals.

HDMI ----- select signal from HDMI/DVI terminals.

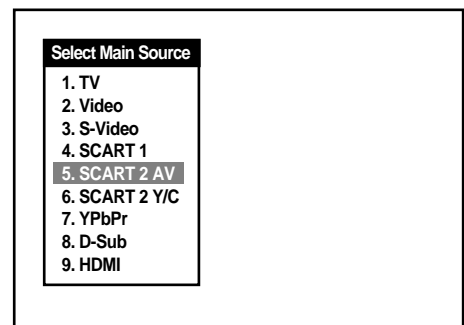

Note:

- When you select to view program from **SCART2** and find the colour is not properly displayed, maybe the unit is receiving **Y/C** signal. To properly display the picture's colour, please select **Scart2 Y/C** instead of **Scart2 AV**
- When using 21 pin Scart Converter to connect **SCART2** interface on the unit with your extended devices, please select **Scart 2 AV** in source select menu.

Setting Picture

Using the Preset Picture Mode

- 1 Press **MENU** to display the menu main page, if the **Video** menu page doesn't appear, then push **ENTER** (Up/Down) repeatedly to display **Video** menu page.
- 2 Press **ENTER** to access.
The **Mode** item will be highlighted automatically.
- 3 Push **ENTER** (Left/Right) to select a desired picture mode.
- 4 Press **MENU** repeatedly to exit.
There are three preset picture modes [Vivid, Standard and Mild] and one user-set picture mode [Custom].
Each preset mode has its own picture settings.
[Vivid]: Select for a bright picture.
[Standard]: Select for a normal picture.
[Mild]: Select for a fine/soft picture.
You may directly use the **P.MODE** button on the remote control to select a desired picture mode.

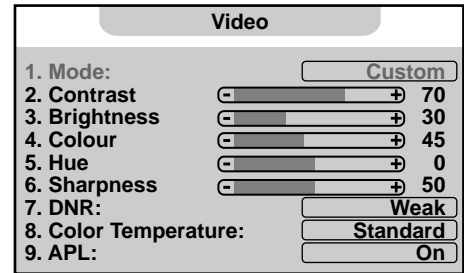

Customising the Picture

- 1 Repeat steps 1~2 in [Using the Preset Picture Mode].
- 2 Push **ENTER** (Down) repeatedly to select the item you wish to adjust.
- 3 Push **ENTER** (Left/Right) to adjust the value of the item.
- 4 Press **MENU** repeatedly to exit.

* The [Hue] item is for NTSC only.

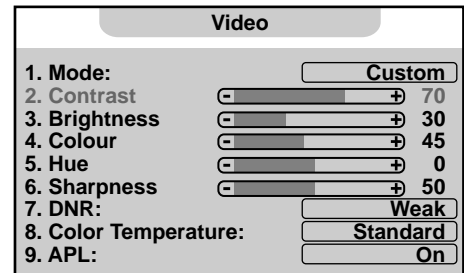

Reducing Picture Noise

- 1 Repeat steps 1~2 in [Using the Preset Picture Mode].
- 2 Push **ENTER** (Down) repeatedly to select the DNR item.
- 3 Push **ENTER** (Left/Right) to select.
- 4 Press **MENU** repeatedly to exit.

Sometimes a noisy picture may appear on the screen because of poor signal. This function helps to enhance the picture quality by reducing the noise.

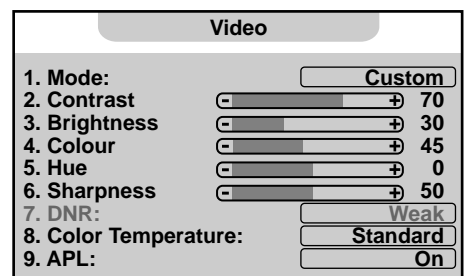

Freezing picture

Press the **FREEZE** button to hold on the image on the screen (the video sources still run). Press again to reactivate the image.



Note:

For the sake of protecting the screen, please do NOT freeze a picture for a long time.

Picture Setting (continued)

Selecting the Preset Colour Temperature

- 1 Repeat steps 1~2 in [Using the Preset Picture Mode].
- 2 Push **ENTER** (Down) repeatedly to select **Color Temperature** item.
- 3 Press **ENTER** (Left/Right) to select.
- 4 Press **MENU** repeatedly to exit.

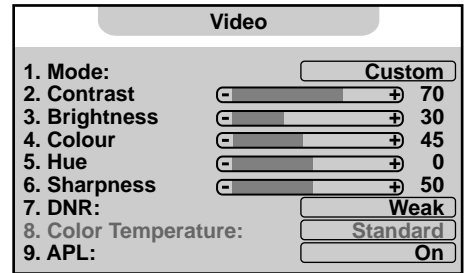

Setting the APL Function On or Off

- 1 Repeat steps 1~2 in [Using the Preset Picture Mode].
- 2 Push **ENTER** (Down) repeatedly to select **APL** item.
- 3 Press **ENTER** (Left/Right) to select **On** or **Off**.
- 4 Press **MENU** repeatedly to exit.

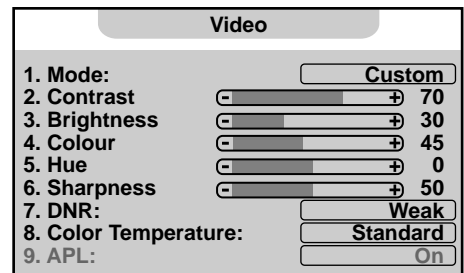

You can use this function to adjust the level automatically so as to obtain better picture effect.

Setting Sound

Adjusting the Volume

You may quickly adjust the volume by using **VOLUME+** or **VOLUME-**. The unit also allows you to adjust volume through OSD menu as follows.

- 1 Press **MENU** to display the menu main page.
- 2 Push **ENTER** (Up/Down) repeatedly to display **Audio** menu page.
- 3 Press **ENTER** to access.
The **Volume** item will be highlighted automatically.
- 4 Push **ENTER** (Left/Right) to adjust the volume.
- 5 Press **MENU** to exit.

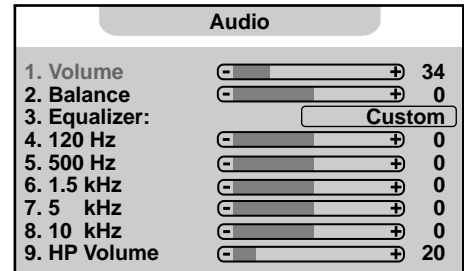

Adjusting the Sound Balance

- 1 Repeat steps 1~3 in [**Adjusting the Volume**].
- 2 Push **ENTER** (Down) repeatedly to select **Balance** item.
- 3 Push **ENTER** (Right) to decrease the left speaker volume;
Push **ENTER** (Left) to decrease the right speaker volume.
- 4 Press **MENU** to exit.

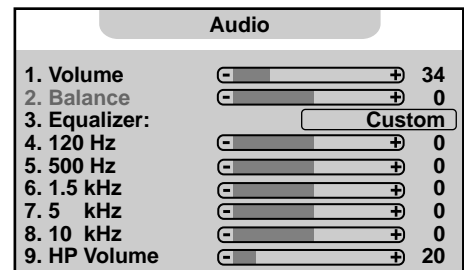

Adjusting the Headphone Volume

- 1 Repeat steps 1~3 in [**Adjusting the Volume**].
- 2 Push **ENTER** (Down) repeatedly to select **HP Volume** item.
- 3 Push **ENTER** (Left/Right) to adjust the headphone volume.
- 4 Press **MENU** to exit.

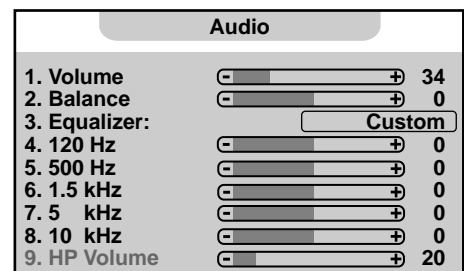

Adjusting Equalizer

The unit provides a Five-Band Equalizer for you to enjoy a high-quality sound. You may select the preset sound effects according to different situations or customise the sound effect by yourself.

- 1 Repeat steps 1~3 in [**Adjusting the Volume**].
- 2 Push **ENTER** (Down) repeatedly to select **Equalizer** item.
- 3 Push **ENTER** (Left/Right) to select.
There are three preset sound effects (**Live**, **Pop** and **Rock**) for your choice according to different situations or you may customise the sound effect as follows.
- 4 Push **ENTER** (Down) repeatedly to select **120Hz**, **500Hz**, **1.5KHz**, **5KHz** or **10KHz**.
- 5 Push **ENTER** (Left/Right) to adjust according preference.
- 6 Press **MENU** to exit.

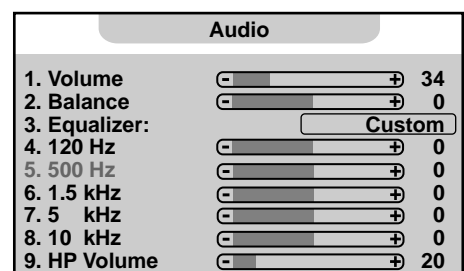
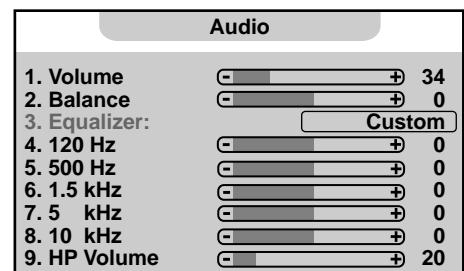

Note:

You may quickly select the preset sound effects by using the **S.MODE** button.

Setting Sound (continued)

Stereo/Bilingual Selection

You can quickly select sound multiplex mode by using the **STEREO** button on the remote control.

● **NICAM Broadcast Selection**

This enables the selection of the reception mode when receiving a NICAM signal. To let you enjoy NICAM broadcasting, this TV set receives NICAM system stereo, bilingual, and monaural broadcasts.

Stereo

When the TV set is receiving a stereo broadcast, press the **STEREO** button to select **NICAM Stereo** or **FORCE Mono**. When **Force Mono** is selected, the TV sound is output monaurally.

Bilingual

When the TV set is receiving a bilingual program, press the **STEREO** button to select **NICAM Dual1**, **NICAM Dual2** or **Force Mono**.

● **IGR (German stereo system) Broadcasts**

This enables the selection of the reception mode when receiving an IGR signal. To let you enjoy IGR broadcasting, this TV set receives IGR system stereo and bilingual broadcasts.

Stereo

When the TV set is receiving a stereo broadcast, press the **STEREO** button to select **FM/AM Stereo** or **Force Mono**. When **Force Mono** is selected, the TV sound is output monaurally.

Bilingual

When the TV set is receiving bilingual program, press the **STEREO** button to select **FM/AM Dual1** or **FM/AM Dual2**.

Note:

When there is no input signal, the unit mutes the sound automatically, the [Audio] menu page can not be accessed and all operations correlative with audio will be denied.

Setting System

Setting Colour System

- 1 Press **MENU** to display the menu main
- 2 Push **ENTER** (Up/Down) repeatedly to display **Program** menu page.
- 3 Press **ENTER** to access.
- 4 Push **ENTER** (Down) repeatedly to select **Colour System** item.
- 5 Push **ENTER** (Left/Right) to select a proper colour system.
- 6 Press **MENU** repeatedly to exit.

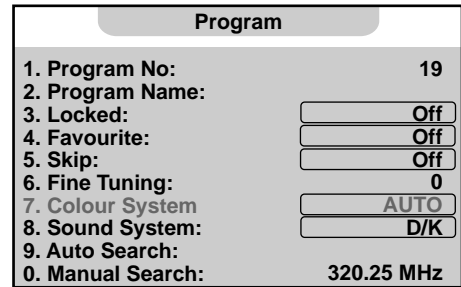

Setting Sound System

- 1 Repeat steps 1~3 in [Setting Colour System].
- 2 Push **ENTER** (Up/Down) repeatedly to select **Sound System** item.
- 3 Push **ENTER** (Left/Right) to select a proper sound system.
- 4 Press **MENU** repeatedly to exit.

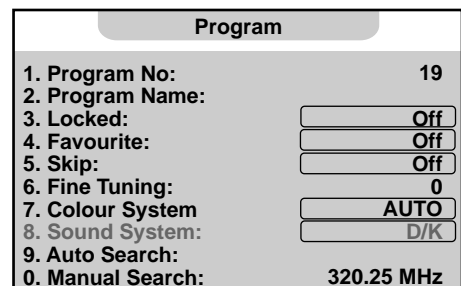

Changing Screen Aspect Ratio

- 1 Press **MENU** to display the menu main page.
- 2 Push **ENTER** (Up/Down) repeatedly to display **Screen** menu page.
- 3 Press **ENTER** to access.
The **Display Mode** item will be highlighted automatically.
- 4 Push **ENTER** (Left/Right) to select a desired screen ratio.
- 5 Press **MENU** repeatedly to exit.

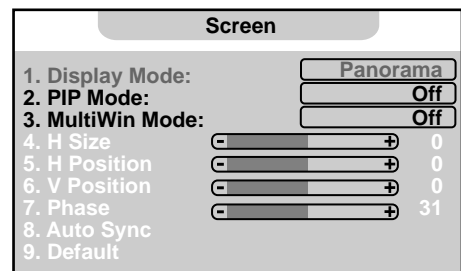

You may also use the **ZOOM** button to select the screen aspect ratio.

Auto --- For Auto signal format. This mode displays the picture format as transmitted by the broadcaster.

16:9 --- For 16:9 signal format. This mode displays a 16:9 aspect ratio picture.

14:9 --- For 14:9 signal format. This mode displays 14:9 aspect ratio picture.

4:3 --- For 4:3 signal format. This mode displays a 4:3 picture at its standard 4:3 size without any stretching.

Panorama --- In this mode the picture is progressively stretched towards each side of the screen.

Zoom --- For 4:3 letterbox signal format. This mode stretches the picture horizontally and crops the top and bottom black bars of the picture

Selecting Menu Language

- 1 Press **MENU** to display the menu main page.
- 2 Push **ENTER** (Up/Down) repeatedly to display **Option** menu page.
- 3 Press **ENTER** to access.
- 4 Push **ENTER** (Down) repeatedly to select **Menu Language** item.
- 5 Push **ENTER** (Left/Right) to select a desired menu language.
- 6 Press **MENU** repeatedly to exit.

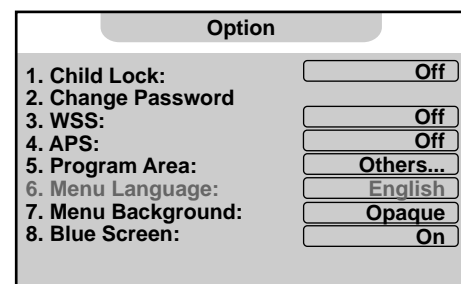

Setting System (continued)

Setting Menu Background

- 1 Repeat steps 1~3 in [Selecting Menu Language].
- 2 Push **ENTER** (Down) repeatedly to select **Menu Background** item.
- 3 Push **ENTER** (Left/Right) to select.
- 4 Press **MENU** repeatedly to exit.

Option	
1. Child Lock:	<input type="checkbox"/> Off
2. Change Password	<input type="checkbox"/> Off
3. WSS:	<input type="checkbox"/> Off
4. APS:	<input type="checkbox"/> Off
5. Program Area:	<input type="button" value="Others..."/>
6. Menu Language:	<input type="button" value="English"/>
7. Menu Background:	<input type="button" value="Opaque"/>
8. Blue Screen:	<input type="checkbox"/> On

Setting WSS

- 1 Repeat steps 1~3 in [Selecting Menu Language].
 - 2 Push **ENTER** (Down) repeatedly to select **WSS** item.
 - 3 Push **ENTER** (Left/Right) to select **On** or **Off**.
 - 4 Press **MENU** repeatedly to exit.
- Note:
If the [WSS] (Wide screen signalling) function is changed from OFF to ON, the unit can identify the WSS signal.

Option	
1. Child Lock:	<input type="checkbox"/> Off
2. Change Password	<input type="checkbox"/> Off
3. WSS:	<input type="checkbox"/> Off
4. APS:	<input type="checkbox"/> Off
5. Program Area:	<input type="button" value="Others..."/>
6. Menu Language:	<input type="button" value="English"/>
7. Menu Background:	<input type="button" value="Opaque"/>
8. Blue Screen:	<input type="checkbox"/> On

Setting Blue Screen

- 1 Repeat steps 1~3 in [Selecting Menu Language].
 - 2 Push **ENTER** (Down) repeatedly to select **Blue Screen** item.
 - 3 Push **ENTER** (Left/Right) to select **On** or **Off**.
 - 4 Press **MENU** repeatedly to exit.
- If the [Blue Screen] is set to [On], the unit displays a blue background when there is no input signal.

In TV mode, when there is no input signal for a certain time, the TV set auto goes to STANDBY mode.

Option	
1. Child Lock:	<input type="checkbox"/> Off
2. Change Password	<input type="checkbox"/> Off
3. WSS:	<input type="checkbox"/> Off
4. APS:	<input type="checkbox"/> Off
5. Program Area:	<input type="button" value="Others..."/>
6. Menu Language:	<input type="button" value="English"/>
7. Menu Background:	<input type="button" value="Opaque"/>
8. Blue Screen:	<input type="checkbox"/> On

Setting Sleep Timer

You can quickly set the sleep timer by using the **SLEEP** button on the remote control. Press this button repeatedly to select a desired value.

Setting Timer

- 1 With the unit working, press **TIMER** to display the timer setting menu.
- 2 Push **ENTER** (Down) repeatedly to select **Current Time**, **Off Time** or **On Time**.
- 3 Press **ENTER** to start setting time
Push **ENTER** (Left/Right) to toggle between hour and minute, push **ENTER** (Up/Down) to adjust.
- 4 Press **MENU** to return back to the upper-level menu.

Note:

If you want to cancel the Off-Timer or On-Timer function, please set the [Off-Time] or [On Time] to [--:--].

Timer	
Current Time	10:04
Off Time	01:20
On Time	12:30
On Prog.	1
On Volume	15

Setting On Program and On Volume

- 1 With the unit working, press **TIMER** to display the timer setting menu.
- 2 Push **ENTER** (Down) repeatedly to select **On Prog.** or **On Volume**.
- 3 Push **ENTER** (Left/Right) to adjust.

In Standby mode, the TV set automatically turns on at the preset time and broadcasts the preset program in preset volume.

Note:

Before setting the **On Prog.** and **On Volume**, please set the **On Time** first.

Timer	
Current Time	10:04
Off Time	01:20
On Time	12:30
On Prog.	1
On Volume	15

Changing Screen Layout

Selecting Screen Layout

- 1 Press **MENU** to display the menu main page.
- 2 Push **ENTER** (Up/Down) repeatedly to display **Screen** menu page.
- 3 Press **ENTER** to access.
- 4 Push **ENTER** (Down) repeatedly to select **MultiWin Mode** menu.
- 5 Press **ENTER** (Left/Right) to select.
- 6 Press **MENU** repeatedly to exit.

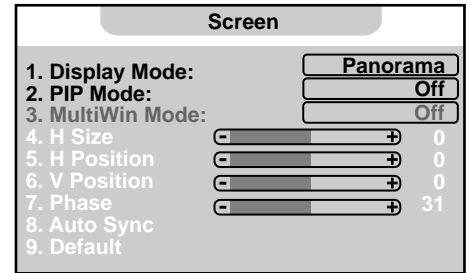

Note:

- You may quickly select screen layout by using the **M.WIN** button.
- The [9 Windows] is for TV mode only.
- The sound can not be output from the headphone jack when in [4 Windows] and [9 Windows].

POP 4:3

The **POP 4:3** feature splits the screen into a double window that allows you to watch two programs at the same time.

Note:

You may use the **POP** button to quickly turn on or off the POP feature.

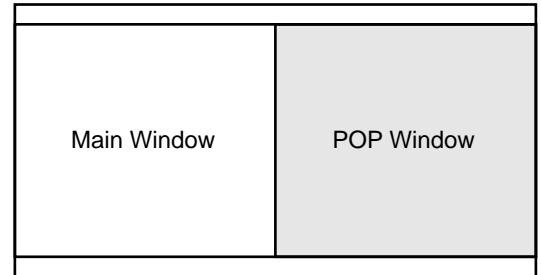

POP Full

When this item is selected, one main window and one scanning windows display on the screen.

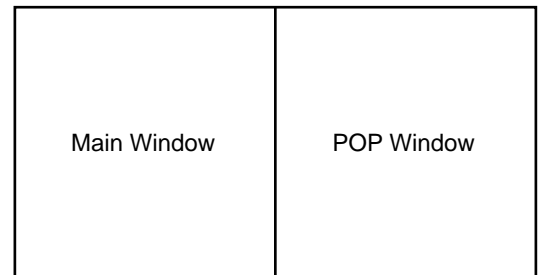

4 Windows

When this item is selected, one main window and three scanning windows display on the screen.

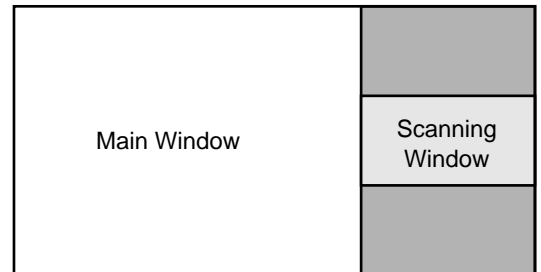

9 Windows

When this item is selected, the screen displays 9 scanning windows. This function enables you to quickly browse all active channel.

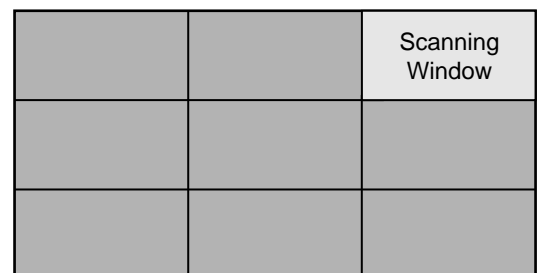

PIP Operation

Viewing the Picture-in-Picture

This unit includes a two-tuner Picture-in-Picture (PIP) feature. This allows you to watch two live broadcasts simultaneously, one in the full size "main" picture and one in a smaller "window" picture. The main window program can come from a TV broadcast or other external source, while the PIP window always displays TV program.

- 1 With the unit working in single full screen, press **MENU** to display the menu main page.
- 2 Press **ENTER** (Up/Down) repeatedly to display **Screen** menu page.
- 3 Press **ENTER** to access.
- 4 Press **ENTER** (Down) to select **PIP Mode** item.
- 5 Press **ENTER** (Left/Right) to select.
Off -Turn off PIP feature.
Up-Left -Turn on PIP feature and display the PIP window on up-left corner of the screen.
Up-Right -Turn on PIP feature and display the PIP window on up-right corner of the screen.
Down-Right -Turn on PIP feature and display the PIP window on down-right corner of the screen.
Down-Left - Turn on PIP feature and display the PIP window on down-left corner of the screen.
Centre -Turn on PIP feature and display the PIP window on centre of the screen.

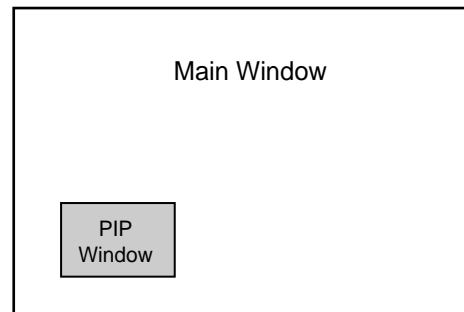
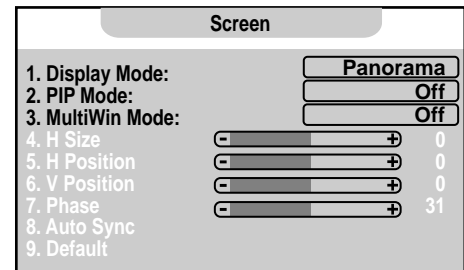

- 6 Press **MENU** repeatedly to exit.

Note:

You may use the **PIP** button to quickly turn on or off the PIP feature.

Using the PIP-POS button

Press the **PIP-POS** button to quickly select the position for PIP window.

Using the ACT.WIN button

Press this button to select either the main window or PIP window in order to perform some operations for the PIP window individually. The unit allows you to apply many operations to the PIP picture such as adjusting volume, changing channels adjusting picture etc.

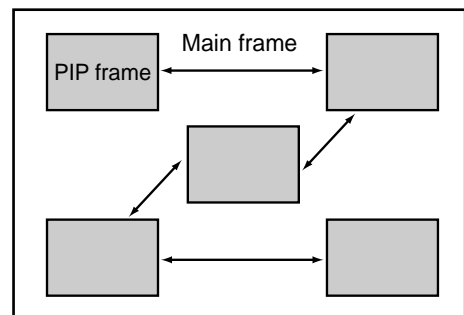

Note:

- ▶ Many but not all adjustments and settings can be applied to the PIP window when the PIP window is selected.
- ▶ The PIP audio is only output through the headphone jack.
- ▶ The NICAM/IGR broadcasts can not be applied to the PIP window.

Swap the Contents of the PIP Image and Main Image

- 1 Press the **PIP** button to display the PIP window.
- 2 Press the **SWAP** button to swap the contents of the PIP window and main window.

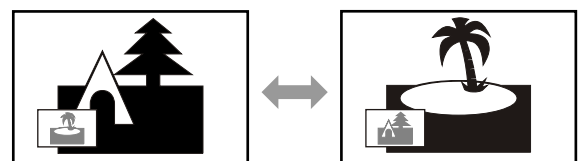

Note:

The Swap function does not work unless the signal source of the main window is set to TV Mode.

Adjustments in D-Sub Mode

With working in D-Sub mode, this unit allows you to perform many adjustments.

Adjusting Image Horizontal Size

- 1 Press **MENU** to display the menu main page.
- 2 Push **ENTER** (Up/Down) repeatedly to display **Screen** menu page.
- 3 Press **ENTER** to access.
- 4 Push **ENTER** (Down) repeatedly to select **H Size** item.
- 5 Push **ENTER** (Left/Right) to adjust until you are satisfied.
- 6 Press **MENU** repeatedly to exit.

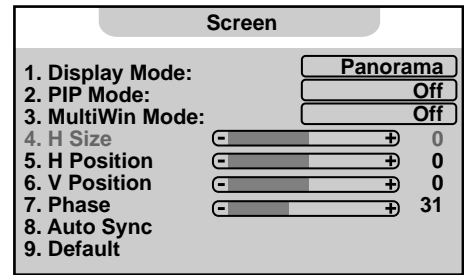

Changing the Position of Image

After connecting the unit to your PC, adjust the position of the screen if it is not well-aligned.

- 1 Repeat steps 1~3 in [Adjusting Image Horizontal Size].
- 2 Push **ENTER** (Up/Down) to select **H Position** or **V Position**.
- 3 Push **ENTER** (Left/Right) to adjust until the picture is well-aligned.
- 4 Press **MENU** to exit.

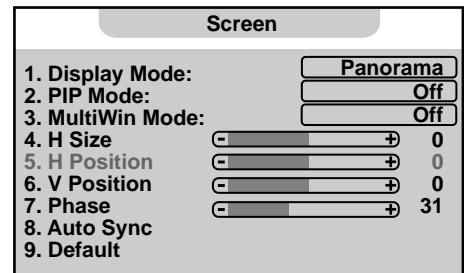

Adjusting the Phase

- 1 Repeat steps 1~3 in [Adjusting Image Horizontal Size].
- 2 Push **ENTER** (Down) repeatedly to select **Phase**.
- 3 Push **ENTER** (Left/Right) to adjust until the picture is well-aligned.
- 4 Press **MENU** repeatedly to exit.

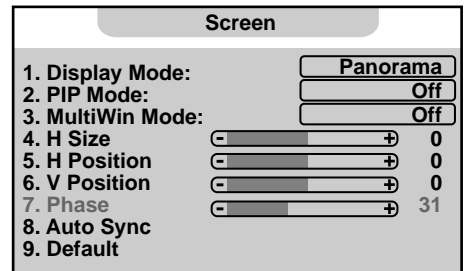

You may find that images blur, depending on the clock phase of your PC's Processor. If you experience blurring, you can obtain a clearer image by adjusting the [Phase] item.

Adjusting the Screen Automatically

- 1 Repeat steps 1~3 in [Adjusting Image Horizontal Size].
- 2 Push **ENTER** (Down) repeatedly to select **Auto Sync** item.
- 3 Press **ENTER** to confirm and press **MENU** repeatedly to exit.

You may quickly adjust the screen by using the **AUTO** button directly. The unit automatically adjusts phase or position, etc.

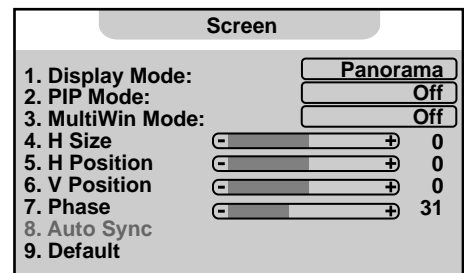

Loading Default Setting

- 1 Repeat steps 1~3 in [Adjusting Image Horizontal Size].
- 2 Push **ENTER** (Down) repeatedly to select **Default** item.
- 3 Press **ENTER** to confirm and press **MENU** repeatedly to exit.

Then the value of H Size. H Position and V Position etc. will be restored to the default value.

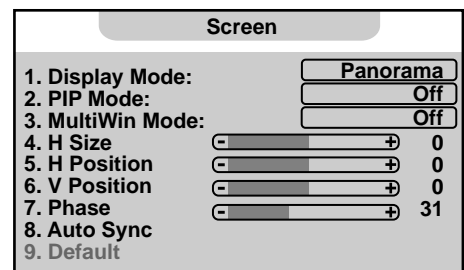

Teletext

What Is Teletext?

Teletext broadcasts pages of information and entertainment to specially equipped television sets. Your System receives Teletext signals broadcast by a TV network, and decodes them into graphical format for viewing. News, weather and sports information, stock exchange prices and programme previews are among the many services available.

Teletext Mode

Teletext is turned on/off with the **TEXT** button on the remote control unit. You can operate your System in Teletext mode directly by inputting commands with the remote control unit.

Turning On or Off Teletext

Select a TV channel providing the Teletext program.
Press the **TEXT** button to display the Teletext with black background.
Press the **TEXT** button again to switch back to TV screen.

Button Functions

ENTER (Up/Down)

Changing Teletext pages.

VOLUME+ or VOLUME-

Adjusting volume.

MUTE

Muting the sound.

Colour (RED/GREEN/YELLOW/BLUE)

You can select a group or block of pages displayed in the coloured brackets at the bottom of the screen by pressing the corresponding colour (RED/GREEN/YELLOW/BLUE) on the remote control unit.

0-9

Directly select any page by using 0-9.

MIX

Press this button to display the Teletext on the screen with transparent background while viewing the TV program simultaneously.

REVEAL

Press the button to reveal hidden information such as an answer to a quiz. Press the button again to hide the information.

SIZE

Press the button to expand the top half of the display. Press it again to expand the bottom half of the display. Press it once more to resume normal size.

HOLD

Press the button to stop updating Teletext pages automatically. Press it again to release hold mode.

UPDATE

Press the button to view the updated teletext page.

Display the TV picture on the screen while waiting for the new teletext page. The characters "???" will appear at the top of left corner of the screen. Then you can input a desired page number. When the update page is available, then the characters "???" will change to the page number.

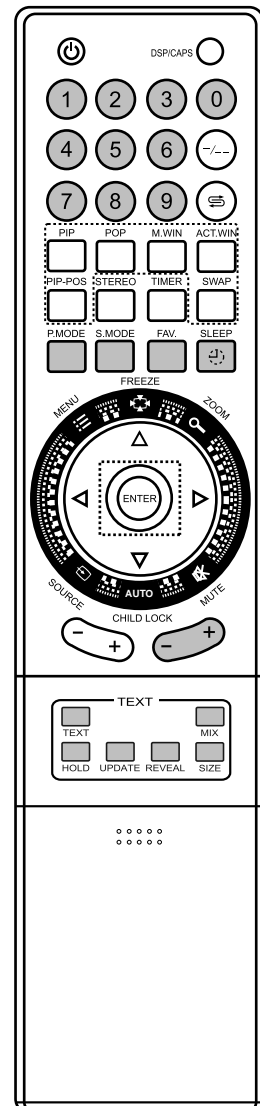

Troubleshooting

Before calling for repair service, check the following items for possible remedies to an encountered symptom.

Symptoms	Check item
"Ghost" or double images	<ul style="list-style-type: none"> • This may be caused by obstruction to the antenna due to high rise buildings or hills. Using a highly directional antenna may improve the picture.
No power	<ul style="list-style-type: none"> • Check that the AC power cord is plugged into the mains socket. • Unplug the power cord, wait for 60 seconds. Then reinsert plug into the mains socket and turn on the unit again.
No picture	<ul style="list-style-type: none"> • Check antenna connections at the rear of the unit to see if it is properly connected to the unit. • Possible broadcast station trouble. Try another channel. • Adjust the contrast and brightness settings. • Select a correct input. • Is a non-compatible signal being input?
Good picture but no sound	<ul style="list-style-type: none"> • Increase the VOLUME. • Check that the unit is not muted.
Good sound but poor colour	<ul style="list-style-type: none"> • Adjust the contrast, colour and brightness settings.
Poor picture	<ul style="list-style-type: none"> • Sometimes, poor picture quality occurs when having activated an S-VHS camera or camcorder connected and having connected another peripheral at the same time. In this case, switch off one of the other peripherals. • Check whether the room is too bright.
Horizontal dotted line	<ul style="list-style-type: none"> • This may be caused by electrical interference (e.g. hair dryer, nearby neon lights, etc.) • Turn off the equipment.
Television not responding to remote control	<ul style="list-style-type: none"> • Check whether the batteries are working. Replace if necessary. • Clean the remote control sensor lens on the unit. • Do not use the remote control under strong or fluorescent lighting. • The batteries should be inserted with polarity (+, -) aligned.
Snowy picture and noise	<ul style="list-style-type: none"> • Check the aerial connection.
No stable or not synchronised D-Sub picture	<ul style="list-style-type: none"> • Check if you have selected the correct D-Sub mode in your PC.
No output from one of the speakers	<ul style="list-style-type: none"> • Adjust Balance in the Audio menu.
Controls buttons do not work	<ul style="list-style-type: none"> • Unplug the power cord, wait for some seconds. Then re-plug the power cord and turn on the unit again.

 **Do not use in hot and cold rooms (location)**

When the unit is used in rooms (locations) with low temperature, the picture may leave trails or appear slightly delayed. This is not a malfunction, and the unit will recover when the temperature returns to normal.

Do not leave the unit in a hot or cold location. Also, do not leave the unit in a location exposed to direct sunlight or near a heater, as this may cause the cabinet to deform and the LCD panel to malfunction.

(Storage temperature: 0°C to +50°C; Working temperature: 5°C to 40°C.)

Note:

If your problem is not solved, restart your TV by turning it off and then on again once.

Never attempt to repair a defective TV yourself.

Care and Maintenance

LCD Display panel information

Note:

The marking or retained image on the LCD panel resulting from fixed image use is not an operating defect and as such is not covered by Warranty. This product is not designed to display fixed image patterns for extended periods of time.

Important Information Regarding Use of Video Games, Computers, Captions or Other Fixed Image Displays.

The extended use of fixed image program material can cause a permanent "shadow image" on the LCD panel.

This background image is viewable on normal programs in the form of a stationary fixed image. This type of irreversible LCD panel deterioration can be limited by observing the following steps:

- A. Reduce the brightness/contrast setting to a minimum viewing level.
- B. Do not display the fixed image for extended periods of time.
- C. Turn the power off when not in actual use.

Cleaning and Maintenance

To clean this unit, wipe with a soft, dry cloth.

If the surfaces are extremely dirty, use a soft cloth dipped in a soap and water solution or a weak detergent solution.

- Use eyeglass cleaner to remove stubborn dirt from the LCD.
- Never use alcohol, paint thinner or benzine to clean this unit.
- Before using achemically treated cloth, read the instructions that came with the cloth carefully.

CAUTION:

If water or similar substances get inside the monitor liquid crystal panel surface, a malfunction may result.

Specifications

Type:	LCD TV
Display Size diagonal:	81cm
Power Supply:	AC100-240V 50/60Hz
Power Consumption:	200W
Dimensions (mm):	1005(W) x 633(H) x 259(D)
Unit Weight (kg):	23

TV system & channel coverage:

System	VHF	UHF	CATV
PAL-D/K	1-12	13-57	Z1~Z37
PAL-B/G	2-12	21-69	X~Z+2, S1~S41
PAL-I	2-12	21-69	
S ECAM-B/G	2-12	21-69	X~Z+2, S1~S41
SECAM-D/K	1-12	21-69	

TV System: PAL/SECAM BG, DK, PAL-I, NTSC (AV)

Supported Display Format:

D-Sub:	640 x 480 @60Hz, 72Hz, 75Hz, 85Hz	
	720 x 400 @70Hz	
	800 x 600 @56Hz, 60Hz, 72Hz, 75Hz, 85Hz	
	1024 x 768 @60Hz, 70Hz, 75Hz, 85Hz	
	1280 x 1024 @60Hz	
YPbPr	480i @60Hz	480P @60Hz
	576i @50Hz	576P @50Hz
	720P @50/60Hz	1080i @50/60Hz
HDMI/DVI	480i @60Hz	480P @60Hz
	579i @50Hz	576P @50Hz
	720P @50/60Hz	1080i @50/60Hz

⚠ Design and specifications are subject to change without notice.

PALSONIC CORPORATION PTY LTD
1 JOYNTON AVENUE
WATERLOO NSW 2017 AUSTRALIA
TEL: (02) 9313 7111
FAX: (02) 9313 7555
www.palsonic.com.au

**PALSONIC CUSTOMER SERVICE
TELEPHONE
AUSTRALIA: 1300 657 888**